



BRINKLEY

RV

MODEL I

OWNER'S MANUAL



BRINKLEY

In our relentless pursuit of product improvement and the ultimate Customer experience, changes may take place at any time to the Model I. It is our goal to strive to keep this manual as up to date as possible. As changes occur, we will provide additional product information documents in the rear pocket of the Owner's Manual. We will also maintain digital versions on our website, BrinkleyRV.com. The QR code below will take you to our site.

Should you have any questions, please do not hesitate to contact us. We are here to serve you!

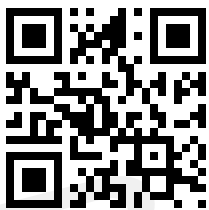

Copyright © 2025, Brinkley RV. No part of this publication may be reproduced, distributed, or transmitted in any form or by any means, including photocopying, recording, or other electronic or mechanical methods, without the prior written permission of the publisher, except as permitted by U.S. copyright law.

Version: 2025-1

Revision Date: 2/1/2025

DEAR BRINKLEY RV CUSTOMER,

Thank you for choosing Brinkley! Your satisfaction with your Brinkley RV and the entirety of your Customer Experience is of the utmost importance to us. We are here to help you along your RVing journey to ensure that your Brinkley RV facilitates the memories that you cherish for a lifetime. Your Brinkley RV is designed and manufactured to meet and exceed all applicable state and federal regulations, codes, and requirements—including the Recreational Vehicle Industry Association's (RVIA) codes and standards. We are committed to the safety of you and your family, keeping you on the road, and camping!

To help you get started along your journey, we supply every Brinkley RV with an Owner's Manual, Warranty Guide, and any manuals made available by the manufacturers of the various appliances and components installed in your RV. We ask that you please read these documents thoroughly, as it is very important that you and your family know how to properly use and maintain your RV, its components, systems, and appliances to ensure a safe camping experience.

You are also provided certain warranties as a benefit of your Brinkley RV Ownership. Those warranties are all included in the separate Warranty Guide provided to you with the purchase of your Brinkley RV. In addition to the owner's manuals, you should thoroughly read through the warranties provided. The Warranty Guide explains not only the provided, but it also includes: coverage validity dates, the extent of coverage, what exclusions or limitations of coverage apply, and how to seek and obtain warranty service and care. Please note that some ongoing maintenance is required to be performed at specified intervals to comply with the requirements of your warranties. Failing to perform required maintenance could result in a partial or complete loss of warranty coverage.

Brinkley RV and our exceptional Dealer Teams are committed to providing you with an amazing Customer Experience. If we are not exceeding your expectations, please do not hesitate to contact us. Our contact information is located at the bottom of each page of your manuals. We are here for you. Please share with us your feedback on how we can better serve you along your journey. We need your valuable input to evolve as a company and achieve our mission:

To provide you with the ultimate Customer Experience that creates the memories you will cherish for a lifetime!

Sincerely,

The Brinkley RV Team

CONTENTS

SEC.01 INTRODUCTION

A. About This Manual	12
B. Owner Information Package	13
C. Manufacturing Certification	13
D. Vehicle Identification Number	14
E. Safety Precautions	15
F. Additional Terminology Used	15

SEC.02 REPORTING SAFETY DEFECTS

A. How to Report Safety Defects	16
---------------------------------	----

SEC.03 SERVICE & WARRANTY

A. Dealer's Responsibilities	17
B. Owner's (Your) Responsibilities	18
C. Obtaining Warranty Service	18
D. Obtaining Emergency Warranty Repair	19
E. Replacement Parts	21
F. Aftermarket Installations and Alterations	21
G. Updating Your Contact Information	21

SEC.04 OCCUPANT SAFETY

A. Develop a Family Safety Plan	22
B. Emergency Weather Planning	23
1. General Information	23
2. Repairing Severe Weather Damage	23
C. Fire Safety	23
1. General Information	23
2. Fire Emergencies	23
3. Common and Important Fire Safety Information	24
4. Fire Extinguishers	25
a. General Information	25
b. Operation	25
c. Disposal	25
D. Emergency Egress Window(s)	26
1. General Information	26
2. Maintenance	26
E. Smoke Alarm	26
1. General Information	26
2. Testing a Smoke Alarm	27

3. Maintenance	28
F. Carbon Monoxide (CO)	28
1. General Information	28
2. Carbon Monoxide (CO) Alarm	29
a. General Information	29
b. Testing the CO Alarm	30
c. CO Alarm Maintenance	30
G. Propane Gas (LP) Alarm	30
1. General Information	31
2. Testing the Propane Gas Alarm	31
H. Indoor Air Quality	32
1. Maintaining Indoor Air Quality	32
2. Improving Indoor Air Quality	32
3. EPA Recommendations	33
4. Chemical Sensitivity and Outgassing	33
a. General Information	33
b. Formaldehyde	34
c. California Air Resource Board (CARB) Notice	34
5. Condensation and Moisture	34
a. General	34
b. Controlling Condensation	34
c. Hot Weather Conditions	35
d. Cold Weather	35
6. When There Is Moisture, There May Be Mold	35
a. General	35
b. Mold Prevention	36
I. Cold Weather Use	36
J. Websites of Interest	36
K. Additional Safety Precautions	37
1. Generators (If Equipped)	37
2. Loading and Weight Distribution	37
3. Passenger Safety	38
4. Propane Appliances and Equipment	38
5. Tire Pressure	38
6. Towing	38
7. Wheel Torque	38

SEC.05 PRE-TRAVEL INFORMATION

A. General	39
------------	----

B. Tow Vehicle Disclaimer	39	L. Roadside Emergency	55
C. Vehicle Labels	39	SEC.06 TOWING & LEVELING	
1. Weight Ratings and Definitions	39	A. Recommended Safety	56
2. Weight Labels	41	B. RV Driving Schools and Seminars	56
3. Federal Certification Label	41	C. RV Braking System	57
4. Tire and Loading Information Label	41	D. 7-Way Harness/Towing Connector Plug	57
5. Cargo Carrying Capacity (CCC) Label	41	E. Breakaway Switch	58
6. RV Length	42	F. Travel Trailer Hitching Procedure	59
a. Travel Trailers	42	G. Towing the RV	60
b. Fifth Wheel Trailers	42	1. Braking and Stopping Distance	60
c. RV Overall Length Exclusions	42	2. Weight and Clearance Limits	60
D. Cargo Capacities and Weights	42	3. Road Conditions	60
1. Maximum Load Rating	42	4. Turning Corners	60
2. Water and Propane (US ONLY)	43	5. Passing	60
3. Loading Your RV	43	6. Backing Up	60
4. Weighing the Tow Vehicle and RV	43	7. Parking	60
a. In General	43	H. Unhitching from the Tow Vehicle	62
b. Weighing Your Tow Vehicle and RV	44	I. Welded Rear Hitch (If Equipped)	63
E. Tire Safety Information	46	J. Leveling the RV	64
1. Introduction	46	K. System Maintenance	66
2. Maximum Load Rating	46	L. Leveling Video Link	67
3. Maximum Inflation Pressure	46	SEC.07 SLIDE-OUT SYSTEMS	
4. Recommended Tire Pressure and Load Limits	46	A. General Information	68
5. Understanding Tire Pressure and Load Limits	46	B. Operation	68
6. Checking Tire Pressure	47	C. Slide-Out Maintenance	69
a. Frequency	47	D. Lippert Through Frame Electric Slide-Out System	70
b. Maintaining Proper Tire Pressure	47	1. Manual Operation	70
7. The Effect of Overloading Your RV and Tires	48	2. Maintenance	70
8. Proper Tire Load Limits	49	3. Service and Adjustments	70
9. Tire Safety Tips	49	E. Lippert In-Wall Slide-Out Systems SlimRack®	71
10. Tire Labeling	49	1. General Information,	
11. Tire Size and Type Designation	50	Extending, and Retracting	72
F. Tire Tread	51	2. Troubleshooting	72
G. Tire Ply Composition and Materials	52		
H. Spare Tire	52		
I. Tire Changing Basics	53		
J. Wheel Nut Torque	54		
K. Tire Warranty	55		

CONTENTS

SEC.08 ELECTRICAL SYSTEMS

A. General Information	74
B. Electrical System Maintenance	74
C. 50-Amp Power Cord	74
1. Connecting Power	75
2. Power Cord Maintenance	75
D. 120-Volt A/C System	76
1. General Information	76
2. 120-Volt Circuit Breakers	76
3. Converter	77
4. GFCI Receptacle	77
E. 12-Volt DC System	78
1. 12-Volt DC USB Ports	78
2. 12-Volt Fuse Panel	78
3. Auxiliary Battery	79
4. Dry Camping	79
5. Maintenance/Replacement of 12V Equipment	80
F. Battery Disconnect Switches	80
G. Calculating Electrical Load	81
1. General Information	81
2. Approximate Electrical Load Ratings	82
H. Replacing Light Bulbs	82
I. Solar Power	82
1. Solar Docking Port	83
2. Solar Power Charging System	83
3. Inverter	83

SEC.09 ELECTRONICS: AUDIO, VIDEO & THE RV CONTROL SYSTEM

A. Introduction	85
B. Audio/Visual System Guide	85
1. Interior Speaker Operation	85
2. Exterior Speaker Operation	85
3. TV Operation—Main Living Area	86
4. TV Reception Basics	86
5. TV Signal Booster	87
6. Cable/Satellite Outlet	88

7. TV Roof Antenna	88
8. Bedroom TV Information	90
9. Gateway WiFi Router (Customer Supplied)	91
10. Furrion Back-Up Camera	91
C. Nebula Video Projector	93
1.General Projector Info	93
2. Operating Projector	93
3. Operating Window	93
D. RV Control System - Lippert OneControl	93
1. RV Device Access and Operation	93
2. Monitor Panel (Control Panel or Command Center)	93
3. Mobile App	94
4. Pairing	94
5. App Access	94
6. App Functions	94
a. All/Home Page	95
b. Modes	95
c. Favorites	95
d. Battery Monitor	96
e. All Lights	96
f. RV Health Monitor	96
g. Holding Tanks	97
h. Device Library	97
i. Auto Set-Up	97

SEC.10 HEATING & COOLING (HVAC)

A. Introduction	98
B. Ducting and Return Air	98
C. Air Conditioner (A/C)	98
1. Cooling vs. Heat Gain	100
2. Air Conditioner Gasket	100
D. Furnace	100
E. Fireplace	101
F. Roof Vents	103
G. Thermostat	104

SEC.11 APPLIANCES

A. General Information	105
B. Microwave	105

C. 12-Volt Refrigerator	106	7. Routine Inspection	122
D. Cooking with Propane	107	8. Filter Cleaning	123
H. Range Top	107	9. Pressure Safety Valve Maintenance	124
SEC.12 PROPANE (LP) SYSTEMS		I. Bathroom Shower	124
A. General Information	109	1. General	124
B. Maintenance	109	2. Maintenance	125
C. Propane Gas	109	3. Shower Door	125
D. Propane Gas Cylinders	110	J. Faucets	126
1. General Information	110	K. Exterior Spray Ports	127
2. Servicing or Filling	111	L. Universal Docking Convenience Center —	
3. LP Gas Container Overfill	111	The Nautilus P4-3 Panel	127
4. Propane Leak Test	111	1. General	127
5. Propane Gas Alarm	112	2. Handle Position and Valve	
6. Installing the Propane Cylinders	112	Routing Information	127
E. Propane Regulator	113	3. Fresh Water Tank PowerFILL	128
F. Propane System Hoses, Tubes,		4. Sanitizing the Fresh Water	
Pipes, and Fittings	114	Tank—"Sanitize"	129
G. Cooking with Propane	114	5. Fresh Tank Supply—"Dry Camping"	130
H. Traveling with Propane	114	6. Utilizing a Pressurized Water	
I. Operating the Propane System	115	Source—"City Water"	130
J. Calculating Propane Use	115	7. Rinsing the Waste Tank—"Tank Flush"	131
K. LP Quick Connect on Exterior	116	8. Integrated Fresh Water Retractable	
		Hose Reel	133
		M. Draining the Fresh Water System	133
		N. Sanitizing the Fresh Water System	134
		O. Winterizing the Plumbing System	134
		P. De-Winterizing the Plumbing System	138
		Q. Black Water and Grey Water Systems	140
		R. Toilet	141
		1. General	141
		2. Preventing Toilet Blockage	141
		3. Cleaning and Maintenance	141
		S. Black and Gray Water Holding Tanks	141
		1. Black Water Tank Preparation	141
		2. Gray Water Tank Preparation	142
		3. Emptying Black and	
		Gray Water Tanks	142
		4. Gray and Black Tank Valve	
		Switches, Sewer Outlet,	
		and Sewer Hose Storage Tube	142
SEC.13 PLUMBING SYSTEMS			
A. Introduction	117		
B. First Use of the Fresh Water System	117		
C. Monitor Panel	117		
D. Water Pressure Regulator	118		
(Customer Supplied)			
E. Water Pump Switch	118		
F. 12-Volt Water Pump	118		
G. Fresh Water Holding Tank	119		
H. Water Heater—Tankless	119		
1. General	119		
2. Controller Operation	119		
3. Safe Operation	121		
4. Water Control Valve	121		
5. High Altitude Use	122		
6. Storage and Transit	122		

CONTENTS

5. Manually overriding the Gray and Black Power Tank Valves	143	F. RV Polishing	163
6. Dump Station Locations	142	G. Damaged Paint	164
7. Vents and Vent Pipes	143	H. Plastic Components	164
8. Drainpipes With Dry Sealing Valve	143	I. Chrome Parts (If Equipped)	164
9. Black Tank Flusher	144	J. Exterior Roof	164
		K. Sidewall Vents	164
		L. Sealants	165
		M. Roof Ladder	165
		N. RV Frame/Chassis	165
		O. Windows	165
		P. RV Storage Preparation	165
		Q. Snow Removal	167
SEC.14 FURNITURE		SEC.18 RV INTERIOR CARE	
A. Dinette Table (If Equipped)	145	A. Cleaning the Interior	167
B. Ottoman (If Equipped)	146	B. Tables, Cabinets, and Drawers	167
C. Entertainment Recliner Sofa (If Equipped)	147	C. Pantry	167
D. Tri-Fold Sofa (If Equipped)	147	D. Wall, Ceiling, and Cabinet Paneling	168
		E. Countertops	168
		F. Vinyl Flooring	168
		G. Dinette Table, Ottoman, and Dinette Chairs	170
		1. Dinette Table (If Equipped)	170
		2. Ottoman	170
		3. Dinette Chairs	170
		H. Entertainment Sofa, Hide-A-Bed Sofa, and Tri-Fold Sofas	170
		1. Entertainment (Recliner) Sofa	170
		2. Tri-Fold Sofa	170
		I. Furniture Upholstery	171
		1. Fabric	171
		2. Vinyl	171
		3. ABS Plastic	171
		J. Décor	172
		1. Glass Décor	172
		2. Window Treatments	172
		3. Blinds and Shades	172
		K. Shower Walls	172
		L. Sink and Shower Fixtures	172
		M. Stainless Steel Sink and Appliances (If Equipped)	172
SEC.15 ENTRY DOOR & STEP SYSTEM			
A. Entry and Baggage Doors	149		
B. Entry Door Step System	149		
C. Entry Door Handrail	151		
D. EntryDoor Handle Extension	151		
SEC.16 AWNINGS			
A. Main Awnings (Dometic 9100 Series)	152		
1. General Safety	152		
2. Opening Awning	152		
3. Awning Lights	153		
4. Setting Pitch Position	153		
5. Closing Awning	154		
6. Manual Overriding the Awning	155		
7. General Care and Use	158		
B. Solera Power Awnings	159		
D. Awning Retracting	159		
E. Pitch Adjustment	160		
F. Maintenance	161		
SEC.17 RV EXTERIOR CARE			
A. General	162		
B. Exterior Cleaning	162		
C. Washing	162		
D. During Cold Weather	163		
E. RV Waxing	1163		

SEC.19 MAINTENANCE

A. Maintenance Checklist	173
1. Prior to Your First Trip in Your RV	173
2. Each Trip	173

SEC.20 BASIC TROUBLESHOOTING

A. Air Conditioner (Roof)	177
1. A/C Will Not Operate	177
2. A/C Operates, but Coil Freezes and Compressor Cycles Prematurely	177
3. A/C Does Not Effectively Get Cold	177
B. Electrical Power	177
C. Furnace	178
D. Interior Lights	178
1. If Lights Flicker	178
2. Lights Dim or are Half Bright	178
E. Microwave	178
F. Monitor Panel	178
1. No Lights at Control Panel When Switch is Pressed	178
2. Holding Tank Lights Deliver False Readings	179
G. Outside Receptacle	179
H. Propane Gas	179
I. Refrigerator	180
1. Control Panel Lights Are Not Illuminating	180
2. Lights Are Illuminating, But Not Properly Cooling	180
3. Frost Buildup on Evaporator Fins	180
J. Running Lights	180
1. Running Lights Not Operating	180
K. Slide-Out	180
1. Runs In and Out Slowly Binds, and/or Squeaks	180
2. Water Entering at the Rear Corners	181
3. Room Will Not Move In or Out	181
L. Termination Valve	181
M. TV Antenna	181
N. Waste Tank	181

O. Water Heater—Tankless	181
P. Water Pump	181
1. Pump Inoperable	181
2. Pump Will Not Prime	181
3. Pump Runs Even When Water Is Off	182
Q. Water System	182
Glossary	183
Maintenance Record	191

NOTES

NOTES

A. ABOUT THIS MANUAL

The Brinkley RV Owner's Manual is intended to safely guide you through the proper use and maintenance of your Brinkley RV along with its unique components and features. Understanding the operational procedures of your Brinkley RV will allow you to better understand how to use your RV and, in turn, maximize your RV experience.

Please know, this manual is not intended to be inclusive of every and all operational aspects of your RV. The separate component and appliance owner's manuals should also be thoroughly reviewed. Because there are various options that may be selected within the build of each RV, each Brinkley RV may contain options, features, and/or components that are not included on your RV.

We wish that we could provide you with all the information required to ensure your safety during towing, transportation, and camping. The campsites you choose, your tow vehicle, and the road conditions you encounter along your journey are too numerous for us to cover all the potential scenarios.

You are ultimately responsible for the safe use, operation, and transportation of your RV.

If you have questions related to safety, please contact us and we will gladly provide you with additional guidance related to your specific camping and transportation scenarios. Additionally, due to our dedication to continuous

product improvements and updates, some photographs, components, systems, and diagrams may be different from what is supplied within this manual. If we can make our products better, we will make those improvements as quickly as humanly possible.

At the time of publication, this information is accurate, but is subject to change at any time without notice. You can access the most up to date version of the Owner's Manual by visiting our website or scanning the QR code located on the back cover of this Owner's Manual.

If you happen to have any additional questions or concerns, or simply need assistance of any kind, please do not hesitate to reach out to your Brinkley RV Dealer or the Brinkley RV Customer Care Team. Below, you will find our contact information. Our contact information can also be located at the bottom of each page of this manual. Remember, we are just one phone call away.

CONTACT INFORMATION:

Email: CustomerCare@BrinkleyRV.com

Phone: (574) 501-4280 or toll free
(888) 502-3460

Address: Brinkley RV
Attn: Customer Care
1655 Brinkley Way East
Goshen, IN 46528

SEC.01 INTRODUCTION

B. OWNER INFORMATION PACKAGE

Within your RV, you will find an Owner's Information Package that contains the Owner's Manual, Warranty Guide, Component Manuals, and Warranty Registrations for the appliances and components within your new Brinkley RV.

- **Before Using Your RV**, it is vital you read all documents within the Owner's Information Package. Your safety is important to us, and we want you to have the best possible experience with your Brinkley RV.

+ NOTICE

Some component manuals will not be provided within your Owner's Information Package and can only be found online via the component supplier website.

- **Register and activate your component warranties** within the required time frame to avoid loss of warranty coverage. Please note that there are some component manufacturers who provide additional warranties beyond that of the Brinkley RV Limited Base and Structural Warranties. Please see [Section 4](#) in the separate Warranty Guide for additional details.

+ NOTICE

Select component suppliers require online registration.

C. MANUFACTURING CERTIFICATION

All Brinkley RVs are required to meet and/or exceed the safety and manufacturing codes, regulations, and standards of the Recreational Vehicle Industry Association (RVIA).

- RVIA and Transport Canada both conduct random product audits on a frequent basis to ensure that all Brinkley RVs are manufactured to U.S. (RVIA) and Canadian (CSA) standards.



- Depending on where the RV is being transported and sold, an RVIA and/or CSA Group label can be found on the sidewall next to the main entry door. This label confirms that your RV has been manufactured to the required codes and standards of RVIA and/or CSA.

+ NOTICE

The RVIA and CSA Codes and Standards are not identical and can vary from each other depending on their requirements.

Content within the Brinkley RV Owner's Information Package including the Owner's Manual, Warranty Guide, Component Manuals, etc. should be considered a permanent component of the RV. In the event this RV is traded or sold, all these documents should remain within the RV for the next owner.

D. VEHICLE IDENTIFICATION NUMBER

Each Brinkley RV is assigned a 17-digit vehicle identification number also referred to as a “VIN.” This identification number is located on a VIN tag which can be found on the A-frame of a travel trailer or hitch (also known as the pin box) on fifth wheels. As a secondary location, the VIN can also be found on the Federal Certification Label
See [Section 5C\(3\)](#).

+ NOTICE

The last seven (7) digits of the VIN are also known as the RV serial number. For example, using the supplied VIN below, the serial number would be 1000001.

Please see the typical de-coding of a Brinkley RV VIN below:

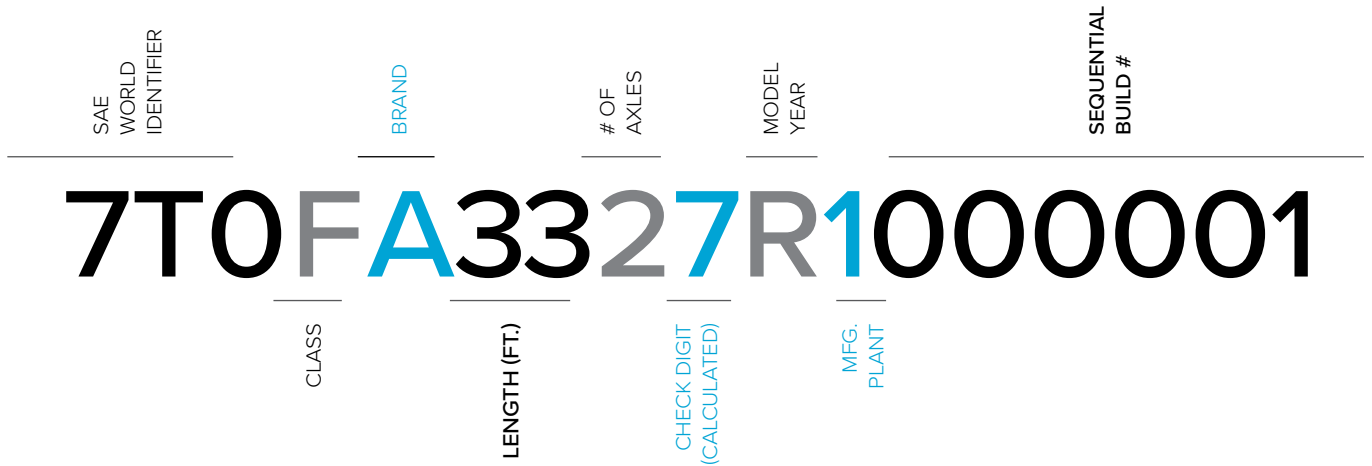

SAE WORLD IDENTIFIER:
7T0 – BRINKLEY RV

CLASS:
F = FIFTH WHEEL
T = TRAVEL TRAILER

BRAND:
Z – MODEL I
G – MODEL G
A - MODEL I-AIRX
1 - MODEL I

LENGTH:
THIS NUMBER IS A GROUPING NUMBER PREDETERMINED BASED ON THE SPECIFIED GROUP THE RV LENGTH FALLS WITHIN RATHER THAN THE ACTUAL LENGTH OF THE RV.

MODEL YEAR:
N – 2022
P – 2023
R – 2024
S – 2025

SEC.02 REPORTING SAFETY DEFECTS

E. SAFETY PRECAUTIONS

There are many safety precautions you should be aware of and take while enjoying your RV. These include but are not limited to:

- Safety during the transportation of our RV.
- Functional safety while utilizing all RV components and features.
- Environmental safety while visiting different locations.
- Occupant safety while staying in the RV over the course of your trip.

Safety is, and should be, exercised in every aspect of your RV experience. The personal safety of you, your family, and those around you are of the greatest importance to us at Brinkley RV.

Many appliances and related equipment within the RV (stove, outdoor grills, water heater, furnace, etc.) will operate on the use of propane and/or will exhaust carbon monoxide. While using these items or any other related potential safety hazard, it is crucial that safety remains your number one priority. Be sure to follow all instructions and warnings related to your RV referenced in this manual as well as each supplier's component manual. Below is a guide to the common safety related symbols utilized throughout this manual to ensure that you are aware of potential safety concerns:

DANGER

This indicates an imminent hazard that, if not avoided or handled correctly, will result in death or serious injury.

WARNING

This indicates a potential hazard that, if not avoided or handled correctly, may result in death or serious injury.

CAUTION

This indicates a potential hazard that, if not avoided or handled correctly, may result in minor or moderate injury.

+ NOTICE

This is used to address best practices that should be utilized and do not commonly result in injury but may lead to property damage if not careful.

F. ADDITIONAL TERMINOLOGY USED

Customer Supplied

Indicates any and all aftermarket items not installed, provided, or included with the RV by Brinkley RV. Any item deemed "Customer Supplied" is not covered under the Brinkley Limited Base Warranty or Limited Structural Warranty.

If Equipped

Indicates any and all items that may be included and/or installed by Brinkley on a particular RV. All items referred to with the phrase "If Equipped," must be installed during the manufacturing process and cannot be installed or added at a later date. The phrase "If Equipped" does not imply or suggest such items are available, supplied, or included with any given Brinkley RV.

Optional

Indicates any and all items that may be an option and/or feature added to a particular Brinkley RV. Some "Optional" items and/or features can only be installed within the manufacturing process and cannot be added once the RV leaves production. The term "Optional" does not imply or suggest such items are available, supplied, or included with any given Brinkley RV.

To ensure safety, from time to time, a recall may be initiated to prevent a possible product failure from manifesting into something greater. A Safety Recall includes any possible malfunction that may lead to personal injury and/or property damage or non-compliance with a related Federal Motor Vehicle Safety Standard. If a recall is deemed necessary, a notice will be mailed to your address on file and emailed if an email address has been provided by you. Please be sure that you supply Brinkley RV with an accurate home address and email address. The purpose of this process is to ensure you are notified of the recall and to ensure the RV is taken to a Brinkley Authorized Dealer or Service Center for correction prior to continuing use. For instructions on how to update your contact information, please see [Section 3G](#) of this manual.

+ NOTICE

It is very important to keep your contact information updated. It is also vital for the unit to be taken to an Authorized Dealer or Service Center to remedy the concern prior to using the RV or related component again.

If you believe your vehicle may contain a defect that can lead to injury, accident, property damage, or death, both Brinkley RV and the National Highway Traffic Safety Administration (NHTSA), should be notified immediately.

In the circumstance NHTSA receives multiple complaints on an issue, an investigation may be opened for review. This is to assist in the determination process required to locate the safety concern and to launch a recall and a remedy campaign (if needed). If NHTSA finds that a safety defect exists in any group of RVs, it may order a recall and require a remedy campaign. Once a recall is established, NHTSA cannot become involved with any action or circumstance between you, the Dealer, and/or Brinkley RV. All communications related to the recall must be

handled by Brinkley RV, your Dealer, and you as the owner of the RV.

A Service Campaign may also be launched for a potential product failure. Unlike a recall, a Service Campaign is less severe in that the product failure is not likely to lead to personal injury. And, unlike a recall, the correction process for a Service Campaign is not mandatory but is highly recommended.

Recalls and Service Campaigns can be found on the NHTSA website. As a reminder, this information will also be mailed to the contact information on the RV file.

To contact NHTSA in the United States:

Please visit their website at

www.safercar.gov;

call their toll-free hotline

at 1 (888) 327-4236

(Hearing impaired (TTY): 1 (800) 424-9153);

or send your correspondence to:

NHTSA Headquarters,

Attn: Administrator,

1200 New Jersey Avenue SE,

Washington, DC 20590

To contact NHTSA in Canada:

(Known as "Transport Canada"),

please visit their website at

www.tc.gc.ca;

call their toll-free hotline

at 1 (800) 333-0510 (819) 994-3328 in the

Gatineau-Ottawa area or internationally),

or send your correspondence to:

Transport Canada-ASFAD,

330 Sparks St.,

Ottawa, ON K1A 0N5

SEC.03 SERVICE & WARRANTY

A. DEALER'S RESPONSIBILITIES

At the time You purchase your Brinkley RV, your Dealer is expected to:

1. DELIVER your RV in the best condition

possible. Your RV must pass the Dealer's Pre-Delivery Inspection (PDI). This inspection tests all systems and components. No Brinkley RV should leave a Dealer lot without first ensuring that all systems and components are in proper working order.

2. PROVIDE an orientation to familiarize you with how to operate all systems and components of your new RV. This orientation is extremely important to ensuring you understand how to properly use the RV prior to camping. Brinkley RV requires its Dealers to provide you with a comprehensive walk through of the RV prior to you leaving their Dealership. You should ask as many questions as possible to ensure you are prepared to safely utilize your Brinkley RV and that you are trained on the use of all the features of the RV. Please contact us directly if the orientation is not completed to your satisfaction.

+ NOTICE

THE ORIENTATION IS THE MOST IMPORTANT PART OF THE RV PURCHASE PROCESS.

This is your opportunity to ask as many questions as possible. The most common frustrations generally result from a lack of understanding how to properly use the various systems of the RV as well as a basic understanding of how the batteries and electrical systems work.

3. REVIEW with you and explain the provisions of the Limited Base Warranty and Limited Structural Warranty.

It is our goal to ensure that you understand your rights and responsibilities to gain the complete benefit of the warranties afforded to you. These warranties, as well as the additional component and appliance warranties, are summarized in the separate Brinkley RV Warranty

Guide. If you have questions, please contact us.

4. SEND your completed Warranty Registration and New Vehicle PDI Checklist to Brinkley RV.

Your Warranty Registration Form is required to be submitted within fourteen (14) days of the RV delivery date to activate your warranty coverage. We expect every Brinkley RV Authorized Dealer to assist you with your warranty registrations and to complete this process prior to you leaving the Dealership. We expect the registrations will be completed by the Dealer on the actual date of purchase. We provide fourteen (14) days from the purchase date to ensure you are afforded adequate time to register. Please contact us immediately if your Dealer did not assist you in registering your warranties.

5. ENSURE that you receive a complete

Owner Information Package. Your Dealer must ensure that you obtain a copy of the Brinkley RV Owner's Manual, individual component manuals, and Warranty Guide.

6. EXPLAIN how to obtain local and out-of-town service for your RV, and its components and appliances.

It is our goal to ensure you know how to obtain service regardless of whether or not the service is covered by your warranties. If your RV has an issue, we want to ensure that it is promptly fixed. You can always contact us directly at any time for assistance.

7. SERVICE all Brinkley RV products. Each and every Brinkley RV Authorized Dealership is required to provide service on all Brinkley RV products. RVs are intended to permit you to travel across North America and explore all it has to offer. If you are traveling and cannot access your selling Dealership, please consult our website for both a Dealer and Mobile Service Locator or call Brinkley Customer Care for assistance.

+ NOTICE

To activate your Brinkley RV One (1) Year Limited Base Warranty and Three (3) Year Limited Structural Warranty you **MUST** complete your Warranty Registration within fourteen (14) days of purchase. In addition to the Brinkley RV registration, you must also complete the required component registrations to obtain those as well. All warranties start on the date of purchase and are in effect for their stated durations. Your Dealer is required to help facilitate all warranty registrations at the time of purchase. If you do not register your RV within the required timeframes, warranty may be forfeited.

B. OWNER'S (YOUR) RESPONSIBILITIES

Routine care and maintenance of your RV is a part of owning your Brinkley RV. The conditions of the roads and highways you encounter as well as exposure to weather and the elements can all take a toll on the condition of your RV. As such, it is your responsibility to care and maintain your Brinkley RV in accordance with the Warranty Guide, component manuals, and this manual. Proper maintenance will improve the longevity of your RV and will prevent situations where warranty coverage is lost due to neglect.

In the circumstance warranty repairs and/or service is needed, it is your responsibility to transport the RV to and from your Authorized Dealer. We ask that you always first attempt to obtain the needed warranty service work through your selling Brinkley RV Dealer. However, if this is not possible for any given reason, Brinkley RV is more than willing to assist you in locating alternatives.

Please do not hesitate to contact us at any time. It is also highly recommended that you obtain insurance coverage on your RV. This coverage will afford you protection for or against personal liability, collision, theft, property damage, etc.

C. OBTAINING WARRANTY SERVICE

In the situation you feel you need to take your RV to an Authorized Dealer for service work of any kind, please first follow the steps below to validate your concern and to obtain service work:

- 1. Verify your complaint.** There is nothing more frustrating than transporting your RV to your Dealer just to find out your RV is operating correctly, is functioning within normal conditions of the RV, or was not used correctly. There are many instances where your Dealer or Brinkley RV can help you before you become frustrated and spend time trying to obtain service.
- 2. Make a list.** If service is truly required, you should also make a prioritized list of all repairs needed and provide this list to the Dealer or Authorized Service Center at the time of scheduling service. We want to ensure that the Dealer or Authorized Service Center schedules enough time to address all your service concerns and they can obtain all necessary parts in advance of your service appointment. The checklist will also help to ensure that the Dealer addresses all your concerns at the time of service.

+ NOTICE

It is very common for service to be delayed due to the parts not being available at the time of service. RV Dealers generally carry many different brands and models of RVs making it difficult to stock all parts required for service. Some replacement parts may take several weeks for the Dealer or Authorized Service Center to obtain. The better you communicate your service needs, the better your service experience will be.

- 3. Be prepared.** Prior to calling your Dealer or Brinkley RV, make sure you have your warranty list prepared, the VIN, and any related past

SEC.03 SERVICE & WARRANTY

service/maintenance paperwork available. Being prepared is critical to ensuring speedy and accurate resolution of your service issues.

- 4. Call ahead.** Due to demand, it is best to contact your Dealer to schedule your service appointment several weeks prior to using your RV. Please take into the account that if parts are needed, repair time may be extended. Holiday schedules may also impact scheduling time.

+ NOTICE

To improve efficiency, any time you reach out to your Dealer or Brinkley RV, please have the name of the individual on the registration, your RV's 17-digit Vehicle Identification Number (located on the A-frame of a travel trailer and on the hitch of a fifth wheel), date of purchase, and a detailed description of your complaint(s).

- 5. Drop off your RV.** Dealers will ask for your RV to be dropped off. This will give them time to properly verify your complaint, identify the cause, and make the correction. Note that there are also instances where service may be able to be performed by a mobile technician. Calling ahead to confirm whether drop-off is required will save you time and reduce frustration.
- 6. Inspect your RV at pick-up.** Prior to picking up your unit, inspect all repairs thoroughly. It is vital to address any concerns or dissatisfactions immediately. You should feel empowered to ask as many questions as you have related to your RV service as your satisfaction is of the utmost importance. If a problem reoccurs after leaving the Dealership, contact the Dealer's Service Manager along with Brinkley RV, to quickly address and resolve the issue.

D. OBTAINING EMERGENCY WARRANTY REPAIR

Emergency warranty repair while you are traveling includes any issue that: (1) prevents the total use of the RV, (2) poses a safety risk, and/or (3) if not remedied, will result in additional damage to the RV. To help you better understand what constitutes an emergency warranty repair, here are a few examples:

EMERGENCY EXAMPLES

(Affects safety and/or prohibits use of the RV)

- Slide-outs will not extend or retract.
- Damage to axles, running gear, wheels or tires prohibits safe transit.
- Damage to any safety equipment required for safe transit or use.
- Gas leaks of any kind.
- Awning will not retract to permit safe transit.
- Jacks will not retract to permit safe transit.
- Refrigerator does not operate.
- Any other item that, if not remedied immediately, could result in personal injury or property damage.

NON-EMERGENCIES

(Items that are frustrating, but do not pose safety risks or loss of RV use)

- Any cosmetic issues (scuffs, scratches, dings, etc.)
- Components or appliances not functioning properly but do not pose safety risks (TVs, stereo equipment, washer, and dryer, etc.)
- Plumbing leaks that will not further damage the unit if left unresolved.
- Non-functioning power awnings.
- Any other items that do not pose a risk to the health and safety of the occupants and others and do not render the unit unusable or uninhabitable.

We understand that non-emergency issues with your RV are still frustrating. However, they should be resolved utilizing the normal service process. Special service priority is given to RVs that require the types of emergency repairs listed above. Should you encounter the need for emergency warranty assistance while in transit, please follow the below process.

1. Locate the nearest Authorized Brinkley RV Servicing Dealer

A Dealer Locator Map can be found at <https://BrinkleyRV.com/pfi8>, or contact **Brinkley RV Customer Care** Monday-Friday 7am–5pm EST at (574) 501-4280 or toll free at (888) 502-3460 or via email at CustomerCare@BrinkleyRV.com.

2. If you are unable to locate a local Authorized Dealer, it may become necessary to use a non-authorized service provider or mobile service. When locating a non-authorized service provider or mobile service, it is best to search online, through resources provided by a local campground, by contacting your Dealer, or with the assistance of the Brinkley RV Customer Care Team.

In emergency situations, if you are unable to reach out to your Dealer or Brinkley RV, please contact **SafeRide**.

SAFERIDE CONTACT:

24/7 Roadside Assistance:
(888) 482-5715

SafeRide Customer Service:
(855) 963-1770
Monday-Friday, 8am–5pm CST

+ NOTICE

Brinkley RV is more than willing to work through a non-authorized service provider to help you obtain the service that you need. However, please keep the following in mind: (i) Service calls are not covered under warranty, (ii) Brinkley will need to approve the repair estimate PRIOR to the work being performed, (iii) we may choose to ship the needed parts versus permit substitutions or use of locally available alternatives, (iv) defective parts may be required to be returned, and (v) payment must be made by the Customer and the Brinkley RV pre-approved estimate will be reimbursed post-repair.

3. If you are able to utilize a local Authorized Dealer or Service location, please proceed as stated in the process provided in [Section 3C](#) above.

4. SafeRide RV Motor Club. As an additional benefit to your ownership of a Brinkley RV, we provide you with complimentary Emergency Service and Roadside Assistance through the SafeRide RV Motor Club for the first twelve (12) months of ownership. This service will be particularly important to you in the event you have need for emergency repairs outside of the normal business hours of your Dealer and Brinkley Customer Care. SafeRide will provide roadside assistance or on-site assistance to temporarily correct a condition that prevents you from towing the vehicle to a service center for repairs.

+ NOTICE

SAFERIDE CONTACT:

24/7 Roadside Assistance:
(888) 482-5715

SEC.03 SERVICE & WARRANTY

SafeRide Customer Service:

(855) 963-1770

Monday-Friday, 8am–5pm CST

We are also including the contact information for SafeRide at the bottom of each page of this manual for your ease of retrieving the information if needed. It will also be included on the exterior sidewall of the unit by the entry door.

E. REPLACEMENT PARTS

Brinkley RV and its Authorized Dealers and Service Centers are the exclusive providers of parts. As a general rule, we recommend you first contact your selling Brinkley RV Authorized Dealer. If an original part is no longer available, Brinkley RV and/or your Dealer will provide an alternative replacement. As always, we are here to help you. Please contact the Brinkley RV Customer Care Team whenever you feel it is necessary to ensure you get the assistance that you need.

F. AFTERMARKET INSTALLATIONS AND ALTERATIONS

Aftermarket installations or alterations to your RV and its parts and components are not covered under any warranty provided by Brinkley RV or the warranties of its component suppliers. In addition, such modifications void any warranty to any related part or location that was possibly affected or changed by the modification made. Whoever performed the work for the alterations or modifications holds the sole responsibility and liability of the work performed and any related warranty. Brinkley RV is not responsible for the safety or quality of modifications performed nor it's related parts, materials, or workmanship of the provider.

G. UPDATING YOUR CONTACT INFORMATION

Updating contact information and new owner information is vital. In the event the RV was stolen, totaled, destroyed, has changed ownership, or personal contact information has been changed, Brinkley RV should be notified right away.

It is required by federal law that Brinkley RV maintain and keep records of products and Brinkley RV owners. These records ensure we can promptly reach out to current owners in the event of a Recall, Service Campaign, or other necessary Customer notification.

+ NOTICE

To update your contact information please email CustomerCare@BrinkleyRV.com with the subject line "Contact Information Update" or mail the updated information to:

Brinkley RV
Attn: Customer Care
1655 Brinkley Way East
Goshen, IN 46528

For questions, please contact Brinkley RV Customer Care at (574) 501-4280 or toll free (888) 502-3460.

Your Brinkley RV is designed to include the features and functions we believe will help provide the ultimate Customer Experience. Rest assured that the safety of you, your family and your RV are of the utmost importance to us. Your Brinkley RV is designed to meet and/or exceeds all safety codes and standards provided by RVIA, or Transport Canada if shipped to "Canada, or otherwise required by law at the time it is manufactured.

It is our priority to ensure all safety items are properly and carefully installed to ensure the safety of all occupants within your RV. To further ensure the safety of you and others, please carefully and completely read and understand this Section.

A. DEVELOP A FAMILY SAFETY PLAN

In case of emergency or severe weather, a Safety Plan should be developed in advance for you, your family, and any other occupants. Be proactive and practice your plan with your RV occupants, especially if children are involved.

1. Prior to using your RV, know where all doors, emergency exit windows, and safety equipment are located.
2. Know where the safety alarms are within your RV, and what it means if they are triggered. Educate everyone on how to properly evacuate the RV. If children are involved, please stress the importance of evacuating the RV with or without an adult in the event of an emergency.
3. Plan a minimum of two (2) ways to evacuate the RV. See also [Section 4D](#) pertaining to Egress Windows for additional information. The first form of exit can include the RV entry door, but the other planned route should not. It may be essential to practice blindfolded. In a real fire situation, smoke may make it difficult, if not impossible, to see.

4. In the case of a fire, make sure everyone knows how to check doors for heat and to leave the door closed if hot; stay low while moving; and avoid inhaling smoke, fumes, and/or gases as much as possible. Placing a cloth over your mouth and nose will assist in protecting you against inhalation of smoke, fumes, or gases.
5. Plan a meeting location near the RV but a safe distance away. Everyone should remain at this location until every occupant is accounted for.
6. Make sure everyone knows how to call 911 from outside the RV and where to go if they do not have a phone. A family emergency contact should also be established and memorized.
7. Safety drills should be discussed and practiced as needed every six (6) months or as frequent as necessary to ensure everyone's safety.

WARNING

WHEN IN A FIRE RISK ZONE, ADHERE TO ALL FIRE AND SAFETY RESTRICTIONS THAT APPLY.

WARNING

BE CAUTIOUS OF THE HEAT INDEX WHEN CAMPING IN HIGH TEMPERATURE CLIMATES. KEEP HYDRATED AND STAY IN AIR-CONDITIONED LOCATIONS DURING A HEAT INDEX WARNING.

SEC.04 OCCUPANT SAFETY

B. EMERGENCY WEATHER PLANNING

1. General Information

It is very important to monitor weather conditions while camping. Weather is known to change with little to no warning and can put you, the RV, the towing vehicle, and all occupants at risk.

Local weather stations broadcasted on TV and radio often provide updated weather conditions and warnings as they occur. Be sure to stay tuned as you are traveling and using your RV. Knowing how to deal with severe weather conditions is important to ensure you and your family's safety. If traveling to an area where weather is known to suddenly shift, a weather radio is recommended.

Weather radios broadcast 24-hour VHF weather observations and forecasts directly from the US National Weather Service (NWS). Frequencies used by the US National Oceanic and Atmospheric Administration (NOAA) weather radio are 162.400, 162.425, 162.450, 162.475, 162.500, 162.525, or 162.550 megahertz (MHz). You can also visit their website at www.noaa.gov.

⚠ WARNING

DURING SEVERE WEATHER CONDITIONS SEEK SHELTER INDOORS OR AS DIRECTED BY THE CAMPGROUND AND/OR APPROPRIATE LOCAL AUTHORITIES.

+ NOTICE

Many emergency shelters do not permit the entry of pets due to health-related reasons and limited space. You as the owner are responsible to create a safety survival plan for your beloved pets. It is also recommended that the plan include a three (3) day supply of food and water for all occupants.

2. Repairing Severe Weather Damage

Please contact your insurance provider right away if your RV is damaged by severe weather. Contacting your insurance provider is required PRIOR to the repair(s) being scheduled and/or performed. Weather damage is covered exclusively by your insurance coverage and is not covered by Brinkley RV or its component manufacturers.

C. FIRE SAFETY

1. General Information

The most common fire safety issues include, but are not limited to, smoking in bed, using flammable solvents and/or cleaning fluids, and leaving children unattended.

2. Fire Emergencies

IN A FIRE EMERGENCY, EVACUATE THE RV FIRST, THEN CALL 911 FROM A SAFE LOCATION.

- In a fire emergency, execute your Family Safety Plan as outlined in [Section 4A](#).
- Ensure everyone knows to stop, drop, and roll if their clothes or hair catch on fire. The basic protocol for stop, drop and roll is as follows:
- **STOP** in place, do not run.
- **DROP** to the ground.
- **ROLL** back and forth, with your hands shielding your face from the flames.



STOP



DROP

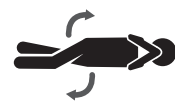

ROLL

3. Common and Important Fire Safety Information

Below is a list that includes common information related to fire safety. This list is not all inclusive of all rules related to fire safety. Common sense and attention to your surroundings may dictate additional guidance and protections that are required to prevent the spread of fire. Please use this list as a guide to ensure that fire safety is **ALWAYS** utilized by you, your family and other occupants of your Brinkley RV:

- **ALWAYS** supervise children around or near any open flames, especially grills, fire pits and campfires.
- **ALWAYS** learn and teach fire safety, prevention, and fire extinguishing practices.
- **ALWAYS** build campfires, place grills, or otherwise utilize open flames away from nearby trees or bushes and adhere to all federal, state and local laws related to fires and burning, including local burning bans and advisories. It is critical to always know and adhere to the restrictions in place for your location. Forest and field fires can be catastrophic to safety and property alike and can quickly spread.
- **ALWAYS** maintain at least a three (3) foot clearance around grills, campfires, your RV, tents, and other structures or combustible materials. This three (3) foot zone should be free of leaves, dry grass, pine needles, or any other combustible substances to prevent the spread of fire.
- **ALWAYS** proactively have an action plan in place to rapidly and completely extinguish a campfire or other open flame.
- **ALWAYS** teach family members and RV occupants how to locate and properly use the fire extinguisher.

- **ALWAYS** replace your fire extinguisher as recommended by the manufacturer of the extinguisher.
- **ALWAYS** call the Fire Department, no matter how small the fire may seem.
- **ALWAYS** assume that, where there is smoke, there may be fire.
- **NEVER** store combustible materials in enclosed areas or near any heat source.
- **NEVER** leave a fire burning unattended. An ember or unextinguished cigarette can cause a fire to quickly spread out of control during dry conditions.
- **NEVER** use water to put out a grease or electrical fire. Utilizing water can spread grease fires and can create an electrocution or shock hazard during an electrical fire.
- **NEVER** assume that your family and other RV occupants are aware of and practice fire safety. It is your responsibility to ensure that everyone is prepared in the event of fire.

Additional information pertaining to fire safety and firefighting can be located at the National Fire Protection Association (NFPA) website www.nfpa.org.

+ NOTICE

Notify Brinkley RV immediately if you feel that a product failure resulted in a fire. Please call Brinkley Customer Care at (574) 501-4280 or toll free (888) 502-3460 for approval before you re-enter the RV, have it moved or repaired, or any debris is removed or cleaned from the unit. A failure to notify Brinkley RV in advance could result in a loss of warranty coverage.

SEC.04 OCCUPANT SAFETY

4. Fire Extinguishers

a. General Information

Fires can spread rapidly. Prior to reaching for the fire extinguisher, remember your Family Safety Plan See [Section 4A](#) and remember that safety is the priority. Property can be replaced. People and pets cannot. If a fire starts in or around your RV, **SAFE EVACUATION OF ALL OCCUPANTS FROM THE RV IS THE FIRST AND UTMOST PRIORITY.**

A dry chemical, Class B/ Class C type fire extinguisher is located near the entry door of your RV. The provided portable fire extinguisher should be utilized on small fires or to help contain larger ones until the fire department arrives on site. Portable extinguishers do have limitations and remember to always put your safety first.



Household fire extinguishers are classified into four types by Underwriters Laboratories (UL):

RATING	INTENDED USE
TYPE A	FOR USE ON FIRES INVOLVING COMBUSTIBLE MATERIALS SUCH AS WOOD, CLOTH AND PAPER.
TYPE B	FOR USE ON FLAMMABLE LIQUID FIRES, INCLUDING KITCHEN GREASE. NEVER USE WATER ON THIS TYPE OF FIRE.
TYPE C	FOR USE ON FIRES INVOLVING ENERGIZED ELECTRICAL EQUIPMENT.
TYPE ABC	WORKS ON ALL THREE TYPES OF FIRES LISTED ABOVE.

b. Operation

When utilizing a fire extinguisher, it is vital to

keep your back facing a clear and safe exit to maintain a safe escape route. Stop and evacuate immediately if the fire cannot be contained or if smoke fills the room.

To operate a fire extinguisher, please follow the below instructions:

TO OPERATE A FIRE EXTINGUISHER, REMEMBER THE WORD: P.A.S.S.

- PULL** the pin. Hold the extinguisher with the nozzle pointing away from you and release the locking mechanism.
- AIM** low. Point the extinguisher at the base of the fire.
- SQUEEZE** the lever slowly and evenly.
- SWEEP** the nozzle from side-to-side until the fire is out.



c. Disposal

For disposal of used fire extinguishers, contact your local fire, sanitation, or environmental protection department for rules and regulations applicable to their safe disposal.

D. EMERGENCY EGRESS WINDOW(S)

1. General Information

The entrance door is and should be your primary exit. In a situation where the entry door has been compromised, the Emergency Egress Window (or exit window) should be your secondary exit route. All egress windows are clearly marked with an 'EXIT' label and have red handles for window operation. See the picture below as an example. Some egress windows include the entire window. There are instances, however, where only a part or portion of the window is intended for egress. It is important to learn the proper use of all Emergency Egress Windows and practice how to operate them prior to an emergency occurring.



Please review and follow the additional information below:

- **ALWAYS** ensure the Egress Windows are not blocked by trees and/or any other obstacles when setting up your campsite.
- **ALWAYS** ensure that the ground around the outside of the RV at the egress window location(s) provides solid ground and an easy escape route.
- **ALWAYS** review proper escape routes in case of an emergency.
- **ALWAYS** locate all Egress Windows and review proper operation with all occupants within the RV.
- **ALWAYS** determine in advance the order of who will exit through the egress window and how it will be performed.
- Before exiting an Egress Window, if possible, place a blanket over the frame for protection.
- **ALWAYS** ensure that the last person to exit the RV, in the case of a fire, knows how to help others escape.
- **ALWAYS** ensure that all occupants of the RV know the predetermined meeting location if an emergency ensues.

2. Maintenance

To prevent the Egress Window seals from sticking, periodically open and close the windows. Before traveling, always make sure ALL windows are locked. It is important to ensure that all locks work properly and that Egress Windows operate properly prior to using the RV. Failing to lock windows prior to transit may result in wind damage to the windows.

E. SMOKE ALARM

1. General Information

On the ceiling of your RV, you will notice a smoke alarm in the main living area. The smoke alarm is intended to alert you as soon as smoke is detected to reduce the risk of personal injury, property damage, or even death from smoke and/or fire. Although smoke alarms are intended to provide you with enough notice and time to escape before a fire spreads, it is important to understand they are not foolproof. Smoke alarms will only be triggered when smoke reaches their sensors. Although a smoke alarm is a necessary safety alert system, common sense and your own senses should be utilized to ensure the safety of you, your family, and RV occupants at all times.

- It is crucial for smoke alarms to be properly located, installed, and maintained.

SEC.04 OCCUPANT SAFETY

- Smoke alarms should not be tampered with and should be inspected on a continuous basis.
 - When the smoke alarm battery is supplying power, a red LED light will flash.
 - If the light is not flashing or if the alarm is chirping, the battery should be changed immediately.
 - A smoke alarm will not function correctly if the battery is missing, installed incorrectly, or is not the correct battery type.
 - If the battery is correctly replaced, and the alarm is still not functioning, replace the alarm.
- If smoke is detected by the alarm, it will trigger the audible alarm until the air is cleared.
- Those who have loss in hearing or specific medical conditions relating to hearing loss should consider using alarms that offer both audible and visual signals. Smoke detectors with visual alarms are NOT installed in your Brinkley RV from the factory.

IF THE SMOKE ALARM SOUNDS:

When the alarm is triggered, a loud repeating alert or siren will sound and the light on the smoke alarm will rapidly flash red.

- The alarm signals that smoke has been detected and requires your immediate attention.
- Never ignore an alarm if it is triggered. Doing so may result in injury or death.
- When the alarm is triggered and it is evident there is a fire, evacuate the RV immediately.
- After you are a safe distance from the RV, call 911.
- Always refer to your Family Safety Plan and ensure all occupants know the plan.

WARNING

Smoke alarms **DO NOT** function without a working battery. **DO NOT** disconnect the battery to silence the smoke alarm and **ALWAYS** make sure the alarm is working for continuous protection.

WARNING

Test all smoke alarms before every camping trip or use of your RV. This is especially important after your unit has been removed from storage and any time you have not utilized the RV for an extended period.

WARNING

Never use an open flame, such as a lighter or match, to test a smoke alarm. Doing so may result in setting fire to the smoke alarm and your RV. Always use the “Test” button on the alarm. If the smoke alarm does not signal right away, check the battery and replace the alarm as needed.

2. Testing a Smoke Alarm

It is vital for smoke alarms to be tested on a weekly basis. When testing, stay an arm’s length away from the alarm to make sure the alarms signal does not injure or harm your hearing during the test.

SMOKE ALARM TESTING PROCEDURE:

1. **PRESS** and **HOLD** the TEST/SILENCE button found on the face of the alarm until the alarm sounds. The alarm may continue for a second or two after the TEST/SILENCE button is released.
2. If the alarm does not sound right away, check the power source (its battery) and then conduct the test again.
3. If the alarm still does not signal, **CHECK** and ensure the alarm is clean of dust and debris.

3. Maintenance

To keep the smoke alarm functioning properly:

- NEVER clean alarms with solvents, cleaning products, water, bleach, or any other substance that may damage the alarm.
- Carefully wipe with a clean rag or vacuum the smoke alarm at least once a month.
- NEVER paint the smoke alarm. Paint may clog or damage the opening of the sensing unit and prevent the alarm from functioning properly.

F. CARBON MONOXIDE (CO)

1. General Information

Carbon monoxide (CO) is a colorless, odorless, tasteless, gas produced by the exhaust of burning fuel or the incomplete combustion of carbon. Sources of CO in or around your RV may be the exhaust from vehicles, generators, heaters, gas stoves and ovens, furnaces, portable grills, and/or any other gas-powered object or appliance.

CO can be poisonous even at low levels of concentration. With exposure to CO, victims tend to first experience nausea, dizziness, a dull headache, weakness, and confusion. In many situations, CO victims dismiss the early warning

signs as just not feeling well and become disoriented to the point they are unable to escape or call for help. Signs and symptoms of CO poisoning will first be seen in young children and pets and should not be ignored. Immediate action is required.

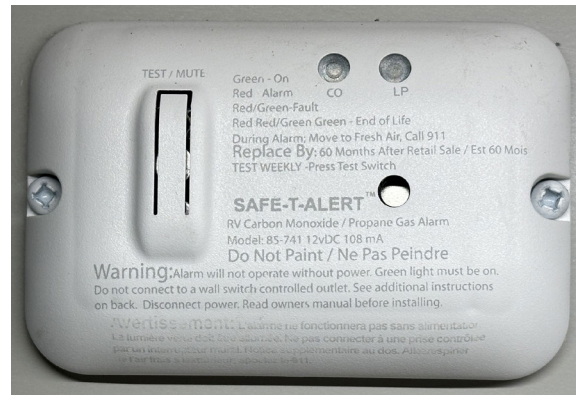

THE CO AND PROPANE GAS ALARM.
SEE [SECTION 4G](#) FOR ITS LOCATION IN THE RV.

CARBON MONOXIDE (CO) POISONING

SIGNS AND SYMPTOMS:

- Mild exposure: Dull headache, running nose, weakness, sore or watery eyes, and/or other flu-like symptoms.
- Medium exposure: Dizziness, drowsiness, and/or vomiting.
- Extreme exposure: Unconsciousness, brain damage, and/or death.

Discuss the signs and symptoms of CO poisoning with all family members.

⚠ WARNING

Many carbon monoxide victims dismiss the early warning signs as just not feeling well and become too disoriented and are then unable to escape or call for help. **NEVER** avoid early warning signs. Doing so may result in brain damage or possibly death.

SEC.04 OCCUPANT SAFETY

⚠ WARNING

If there are other vehicles or generators running nearby, there is a chance for exhaust fumes to enter into your RV. The best protection against carbon monoxide is proper ventilation and the use of a Carbon Monoxide Alarm. To maintain proper ventilation within your RV, make sure the vents on all ventilation systems are clear of snow, leaves, or any other possible debris.

2. Carbon Monoxide (CO) Alarm

a. General Information

Carbon Monoxide Alarms will sound when the CO reaches a potentially dangerous level within your RV. Upon hearing this alarm, you should quickly evacuate your RV and remain clear of the unit until the RV is well ventilated and the alarm discontinues.

- It is crucial for CO alarms to be properly located, installed, and maintained.
- CO alarms should not be tampered with and should be inspected on a continuous basis.
- When the battery is supplying power, a red LED light will flash.
- If the light is not flashing or if the alarm begins chirping, the battery should be changed immediately.
- A CO alarm will not function correctly if the battery is missing, installed incorrectly, or is the wrong type.
- If the battery is correctly replaced, and the alarm is still not functioning, replace the alarm.
- If CO is detected by the alarm, it will trigger the audible alarm until the air is cleared. Those who have loss of hearing or specific medical conditions relating to hearing loss should consider using alarms that offer both audible and visual signals.

IF THE CARBON MONOXIDE ALARM SOUNDS:

1. Ventilate the RV IMMEDIATELY.

Open all possible doors and windows.

- a. **CHECK** that all occupants are accounted for.
- b. **CALL 911** for your local emergency service or fire department.
- c. **DO NOT** re-enter the RV and stay clear from its openings until the emergency responders arrive or until the CO alarm ceases due to proper ventilation and removal of the CO from the RV.

2. Confirm that another motor vehicle or nearby RV is NOT the source of the CO.

3. If the CO alarm signals again within a 24-hour period:

- a. **REPEAT** step 1 in its entirety.
- b. **BEFORE** continuing use of your RV, **CALL** a qualified appliance technician to inspect all appliances utilizing gas and their associated gas lines to investigate the sources of carbon monoxide entry.
- c. **IF PROBLEMS ARE IDENTIFIED** during the inspection process, service the equipment **IMMEDIATELY** and **DO NOT** continue use of your RV until repairs are completed.
- d. **NOTE** all combustion equipment not inspected and provide maintenance as needed per the supplier component manuals.

⚠ WARNING

CO alarms **DO NOT** function without a working battery. **DO NOT** disconnect the battery to silence the smoke alarm and **ALWAYS** make sure the alarm is working for continuous protection.

b. Testing the CO Alarm

It is vital for CO alarms to be tested on a weekly basis. When testing, stay an arm's length away from the alarm to make sure the alarm's signal does not injure or harm your hearing. Below are the testing instructions.

TESTING THE CO ALARM:

- Press and hold the **TEST/SILENCE** button found on the face of the alarm until the alarm flashes red. Once flashing, the alarm will then signal 4 times and repeat for 5-6 seconds.
- If the alarm does not signal in this manner, check the power source and then test again.
- If the alarm still does not signal, **CHECK** and ensure the alarm is clean of dust and debris.
- If the alarm still does not sound, replace the CO alarm immediately through your Dealer.

⚠ WARNING

DO NOT remain within close proximity of alarm when sounding. Exposure within close range may be harmful to hearing. When testing, stay at arm's length away.

⚠ WARNING

Never test the CO alarm with vehicle exhaust or any other form of exhaust. This may lead to permanent damage and voids your warranty. This may also lead to personal harm.

⚠ WARNING

Test all CO alarms before every camping trip or use of your RV. This is especially important after your unit has been removed from storage. If the CO detector fails to test correctly, replace it immediately. Failure to do so may result in brain damage, injury, or death.

⚠ WARNING

The CO alarm sounding indicates potentially toxic levels of carbon monoxide which may result in brain damage or death. CO alarms will only indicate gas is present at the sensor and does not indicate CO in other possible areas.

+ NOTICE

Replacing the CO alarm yourself can void the warranty. Be sure to use your Authorized Dealer while under warranty.

c. CO Alarm Maintenance

To keep the CO alarm functioning properly:

- **NEVER** clean alarms with solvents, cleaning products, water, bleach, or any other substance that may damage the alarm.
- **ALWAYS** carefully wipe the CO alarm with a clean rag or vacuum the smoke alarm at least once a month.
- **NEVER** paint the CO alarm. Paint may clog or damage the opening of the sensing unit and prevent the alarm from functioning properly.

G. PROPANE GAS (LP) ALARM

1. General Information

Propane gas is used in many of the appliances within your RV. Examples include, but are not limited to, the furnace, water heater, ovens and cook tops, portable grills, etc. If a leak occurs, because propane is heavier than air, it will collect in lower areas. Because of this, a Propane Gas Detector is installed along the lower base of your wall in an open area.



SEC.04 OCCUPANT SAFETY

- It is crucial for propane detectors to be properly positioned, CO and Propane Gas Alarm installed, and maintained.
- Propane detectors should not be tampered with and should be inspected on a continuous basis.
- When the LED on the front of the detector is green, the alarm is active. If propane, acetone, alcohol, butane, and/or gasoline is detected by the detector, it will trigger the alarm until the air is cleared. Such chemicals can be found in deodorant, perfume, cologne, wine, adhesive, liquor, lacquer, kerosene, the propellants of aerosol cans, and most cleaning agents.
- Those who have loss in hearing or specific medical conditions relating to hearing loss should consider using alarms that offer both audible and visual signals.



IF THE PROPANE GAS DETECTOR IS ALARMED:

1. Immediately **EXTINGUISH** all flames, smoking materials, and **SHUT OFF** all gas related appliances such as the stove, heater, furnace, refrigerator, etc. **DO NOT** touch any electrical switch, use electronic devices or appliances, or cellular devices.
2. **EVACUATE** everyone from the RV immediately. Use your Family Safety Plan to safely evacuate everyone from the RV. See [Section 4A](#).
3. **OPEN** all door(s) and windows to ventilate the RV.
4. **SHUT OFF** all gas supply at the LP tank valve and any other provided source. **DO NOT** start any vehicle engine, open flame, or generator near the RV.
5. **DETERMINE & REPAIR** the source of the leak.
6. **DO NOT RE-ENTER THE RV UNTIL THE PROBLEM IS CORRECTED.**
7. **PRIOR TO USING THE LP SYSTEM OR ANY LP RELATED APPLIANCE, CONTACT YOUR DEALER .. OR A GAS EXPERT TO CORRECT THE PROBLEM.**

⚠ DANGER

The sounding of this device means that there is a presence of LP gas, which may result in fire and/or an explosion. Leaks generally occur in LP gas piping and/or the LP gas appliances. Follow all information found within the supplier component manuals. Failure to do so may lead to fire and/or an explosion causing property damage, personal injury, or death.

⚠ WARNING

High temperatures activate glues and adhesives within your RV and create a vapor. If a unit is closed on a hot day, the chemicals and vapors can collect creating a toxic level detectable by the Propane Gas detector.

H. INDOOR AIR QUALITY

1. Maintaining Indoor Air Quality

- **ALWAYS** provide proper ventilation within your RV.
 - Proper ventilation carries pollutants and emissions out of your RV.
 - Poor ventilation will cause air pollutants to gather and potentially reach dangerous, toxic levels. Heat and humidity can cause this occurrence to accelerate.
- Clean the RV on a regular and continuous basis.
- Be proactive to protect against harmful air pollutants. These include but are not limited to molds, pet dander, cleaning agents, pollen, and carbon monoxide from the use of charcoal, propane, or other fuel types.

+ NOTICE

Children, the elderly, and those with allergies, asthma, heart disease, and/or with chronic lung disease are at greatest risk for reactions to poor air quality.

2. Improving Indoor Air Quality

- Open windows and doors so fresh air is available inside your RV.
- Spend time outside.

CONTROL MOLD, ALLERGENS, AND OTHER SPORES:

- Fix any water leaks immediately as they are found.
- Properly ventilate the RV.
- Clean on a regular basis removing dust, dander, pet fur, water, etc.
- Do not allow water or moisture to collect within the RV.
- Keep the windows closed and periodically run your air conditioner (A/C) and/or a dehumidifier (Customer Supplied).
- Clean any mold or mildew immediately that can be seen or smelled with proper solutions. We recommend one (1) cup bleach to one (1) gallon of water as a cleaning agent.

+ NOTICE

Never mix cleaning agents that can cause chemical reactions (ex: bleach and ammonia). Do not smoke within your RV or near an entry point into your RV. Do not use bug spray within your RV.

3. EPA Recommendations

The Environmental Protection Agency (EPA) provides and recommends three (3) basic strategies to improve indoor air quality within your RV:

- **Remove sources.** By eliminating sources of pollution and their possible emissions, you will effectively improve indoor air quality. This strategy is important and effective for the following pollutants:

SEC.04 OCCUPANT SAFETY

- **Biological Contaminants:**
bacteria, molds, mildew, spores, viruses, dander, and pollen.
- **Household Products:**
Cleaning agents, disinfectants, cosmetic products, paints, and varnishes.
- **Pesticides or other chemicals.**

- **Ventilation.** Proper ventilation increases fresh air flow within the RV and lowers the concentration of pollutants present. Open doors, windows, and vents to allow fresh air to flow through your RV. Operating fans, air purifiers, and the RV air conditioner(s) or furnace also helps to bring in fresh air and force out stale, polluted air.
 - When the RV remains closed, air flow decreases increasing the presence of air pollutants.
 - Follow the recommendations within this manual to assist in avoiding exposure to air pollutants and outgassed chemicals.

- **Air Cleaners.** Air cleaners are designed to remove specified pollutants from the air. Their effectiveness depends on how well they are capable of collecting pollutants within their filters. An effective air cleaner requires an intake, proper filters, and a high air circulation return rate. Being that there are many types on the market, it is important to thoroughly research the product. Many smaller, less expensive models are not as efficient with particle removal. Most common air cleaners DO NOT remove gaseous pollutants.

+ NOTICE

Chemical outgassing is a normal process that occurs and is not a defect within your RV. Please follow the recommendations within [Section 4H\(4\)](#). Given that outgassing is normal and to be expected, it is not covered under any warranty provided.

4. Chemical Sensitivity and Outgassing

a. General Information

Upon purchasing a new RV, you may notice a chemical odor due to outgassing. More commonly, you will notice this after the RV has been closed up for a period of time. This is normal, and not a defect.

“Outgassing” is the release of gas or chemical vapor that was once trapped, frozen, dissolved, or absorbed within a material. This tends to occur in new RVs and will lessen over time as the materials acclimate and outgas.

Like a home, your RV is constructed using materials including, but not limited to linoleum, carpet, insulation, plywood, upholstery, and other common building materials. Being that these materials differ in chemical make-up from one another, it is to be expected they will outgas various chemicals, including formaldehyde. Increased temperatures and humidity will increase the outgassing process.

Being that RVs are much smaller than a home, the air exchange within an RV is greatly reduced. Minimal air exchange makes the smell of outgassed chemicals more exaggerated and noticeable.

+ NOTICE

If not properly ventilated, chemical sensitivity such as eye, nose, and throat irritation along with nausea, headache, or other asthma-like symptoms may occur. Children, the elderly, and/or those with a history of lung-related problems may be more susceptible to the effects of the outgassing process.

b. Formaldehyde

Formaldehyde is a naturally occurring substance that is used widely in building materials such as plywood, pressed wood, paneling, and medium density fiberboard (MDF), all which are commonly used within the RV construction. Because formaldehyde is contained within some of the materials used within your RV and some people have sensitivity towards the chemical, it is important you properly ventilate your RV as instructed in [Section 4H](#).

c. California Air Resource Board (CARB) Notice

Formaldehyde is used widely in building materials such as pressed wood products, particleboard, hardwood plywood paneling, medium density fiberboard (MDF), and plywood which are commonly used throughout the Recreational Vehicle Industry. As mandated by the RV Industry, Brinkley RVs contain composite wood products (hardwood plywood, particle board, and MDF) that comply with the California Air Resource Board (CARB) formaldehyde emission standards under California Code of Regulations § 93120.2(a) Phase 2 (P2).

+ NOTICE

Brinkley RV is compliant with the EPA Formaldehyde Standards for Composite Wood Products under Title IV of Toxic Substances Control Act and the California Air Resource Board (CARB) formaldehyde emission standards under California Code of Regulations

§ 93120.2(a). These can be found at <https://www.epa.gov/formaldehyde/formaldehyde-emission-standards-composite-wood-products> and <https://ww3.arb.ca.gov/research/indoor/formaldehyde.htm>.

5. Condensation and Moisture**a. General**

When staying in your RV for extended periods, condensation may occur within your RV if precautions are not properly taken. “Condensation” refers to when vapors found in humid air collect as water. Commonly, this will form in out-of-sight locations such as inside cabinets, closets, on ceiling panels, etc. Not only can condensation cause damage to your RV, it can also damage your personal belongings. When not properly controlled, condensation is often misconstrued as a water leak.

To minimize condensation within your RV, proper ventilation should be practiced. The use of a dehumidifier (Customer Supplied) is recommended if proper ventilation is not obtainable or if there is high humidity in the ambient air.

b. Controlling Condensation

To reduce moisture within your RV, please do the following:

- Ventilate the RV as often as possible.
- When bathing, showering, drying hair, etc. within the bathroom, keep the bathroom door closed and open the roof vent with the fan on. The exhaust fan should be left on until all moisture exits the RV.
- When cooking, keep the microwave or range exhaust fan on (If Equipped). Cooking releases heat and moisture that may allow condensation to quickly build.

SEC.04 OCCUPANT SAFETY

- **DO NOT** hang wet clothes inside your RV to dry.
- Keep a constant source of airflow within your unit to prevent condensation and mildew from forming. (i.e., fan, A/C, air purifier, dehumidifier).
- Keep temperatures cool and constant throughout the RV, including in cabinets, closets, and drawers.
 - While storing your RV, leave cabinets, closet doors and drawers partially open.
 - On an extended stay, periodically open closed off areas such as closets, cabinets, and drawers to allow ventilation.

+ NOTICE

Cabinets, closets, and drawers filled with stored goods and items will prevent circulation and may lead to condensation.

c. Hot Weather Conditions

When traveling in areas of high temperature, start the air conditioner (A/C) early in the day to help remove humidity while lowering the temperature in the RV. This will help prevent condensation and water accumulation leading to possible damage.

d. Cold Weather

- During cold weather, utilize your vents and exhaust fans on a continuous basis. This will help to lessen the amount of moisture in the air. Keeping your RV closed up during cold conditions will increase the amount of condensation build up within your RV.
- Manage inside temperatures accordingly. As you increase the temperatures within your RV and as the temperatures outside fall, this temperature differential will cause condensation to accumulate in areas that are not insulated as well as others (i.e., windows, vents, wall studs, etc.).

6. Where There Is Moisture, There May Be Mold

a. General

“Molds” are microscopic organisms that can virtually live in any environment and under any condition. Mold requires a source of moisture (i.e., high humidity, wet/damp materials, standing water) to thrive and can grow in temperatures between 40° and 100° Fahrenheit (4.44° and 37.78° Celsius respectively).

According to the Center for Disease Control (CDC), exposure to damp and moldy environments may cause a variety of health-related concerns:

- For those sensitive to molds, exposure may result in coughing, wheezing, nasal congestion, and/or irritation of the eyes, throat, and/or skin.
- Those allergic to molds or who have compromised immune systems or lung-related conditions may have more severe reactions to exposure.

Mold can be harmful to many materials within your RV, especially natural wood products and fabrics. Please follow the tips below to help control moisture within your RV and the prevention of mold and mildew growth:

- When bathing, showering, drying hair, etc. within the bathroom, keep the bathroom door closed and open the roof vent with the fan on. The exhaust fan should be left on until all moisture exits the RV.
- When cooking, keep the microwave or range exhaust fan on (If Equipped). Cooking releases heat and moisture that may allow condensation to quickly build.
- **DO NOT** hang wet clothes inside your RV to dry;
- Keep a constant source of airflow inside your RV to prevent condensation and mildew from forming. (i.e., fan, A/C, air purifier, dehumidifier).
- Ventilate your RV as often as possible.

b. Mold Prevention

To help with the protection against mold within your RV, follow the below preventative measures:

- Regularly clean high traffic areas that have water present including the kitchen, bathroom, and convenience center (See [Section 14L](#) for information on the convenience center). On safe surfaces, mold and mildew cleaning agents are recommended.
- Clean and dry all standing water and spills immediately.
- Remove all damp items within your RV.
- Check sealants regularly. Reseal as needed to avoid water leaks.

I. COLD WEATHER USE

When using your RV in freezing or below freezing temperatures, the following precautions MUST be taken:

- Water sources such as the freshwater and drainage systems require added protection against freezing.
- Sufficient power and propane are required to run your furnace to prevent possible freezing.
- Proper ventilation should be practiced helping reduce condensation. A dehumidifier (Customer Supplied) may be required if ventilation is not sustainable.
- Prior to operating slide-outs, compartment doors, locks, windows, vents etc., check for ice to avoid possible damage from occurring.

+ NOTICE

Brinkley RVs are not manufactured for sub-zero temperatures.

J. WEBSITES OF INTEREST

We also recommend that you visit the following websites that maintain information about indoor air pollutants, including molds and formaldehyde, along with ways to improve indoor air quality:

- www.epa.gov/indoor-air-quality-iaq/inside-story-guide-indoor-air-quality.
- www.epa.gov/mold.
- www.atsdr.cdc.gov.

WEBSITE DISCLAIMER OF WARRANTY

Brinkley RV holds no liability whatsoever in connection with the services, information, and/or materials provided within the websites and/or external links noted in this manual.

This information is provided “AS IS” and is for informational purposes only. The use of this information provided is at your own risk. Brinkley RV is not liable for any possible errors, inaccuracies, or omissions that may be present within the information regardless of the delivery of information, decisions made, or actions taken/not taken in reliance to the furnished external information.

Brinkley RV accepts no liability or responsibility whatsoever regarding the information provided on any external source linked or provided within this manual. This information is meant to be taken as general knowledge and not intended to address any specific situation for any given individual or entity.

Brinkley RV has no control over any external links provided and does not hold responsibility if the information is not fully comprehensive, accurate, complete, and/or up to date.

SEC.04 OCCUPANT SAFETY

Brinkley RV has no liability for any loss and/or injury caused, in whole or part, by the actions, negligence, and or omissions of any contingencies beyond its control for compiling, delivering, or obtaining any information. This information is not to be considered professional nor shall it comprise legal advice.

DISCLAIMER OF ENDORSEMENT

References that may be made within the external or third-party links such as specific commercial products, processes, or goods specific to trademark, manufacturer, or otherwise, shall not be taken as recommended, favored by, or endorsed by Brinkley RV.

Brinkley RV does not exercise any form of editorial control over the information found within any provided external location. Brinkley RV is not responsible for the content within such external sites and does not warrant, guarantee, or endorse any referenced products, services, information, schools, or goods described or offered within these sources.

K. ADDITIONAL SAFETY PRECAUTIONS

1. Generators (If Equipped)

Generators built specifically for RVs should be the only type used within your Brinkley RV. It is important to only operate a generator (If Equipped or Customer Supplied) in an open, outdoor area to permit the exhaust to dissipate. When using a generator, be sure to close all windows, compartments, and entry doors to prevent carbon monoxide from entering your RV. Please refer to [Section 4E](#), for carbon monoxide warnings and additional detail.

+ NOTICE

Generators are not intended to power sensitive electronics without using the appropriate protections such as a line conditioner and surge protectors. Sensitive electronics in need of protection include, but are not limited to, computers, TVs, printers, audio equipment, and video gear. Such electronics should only be operated on inverter-based generators or pure sine wave generators.

2. Loading and Weight Distribution

- **NEVER** surpass the RV's Cargo Carrying Capacity or Gross Vehicle Weight Rating.
- **ALWAYS** distribute the cargo weight evenly throughout the RV.
- **ALWAYS** position heavy items on the floor in the center (closest to the axles) of the RV.
- **ALWAYS** balance weights front-to-rear and side-to-side.

3. Passenger Safety

NEVER allow a passenger to ride inside your RV while in motion. This is against the law in many states and for safety reasons should be avoided.

4. Propane Appliances and Equipment

- **ALWAYS** turn **OFF** all propane and gas related appliances and equipment (including tanks) **PRIOR** to departing with your RV.
- **ALWAYS** know and understand all propane and gas related safety warnings and follow all manufacturer recommended operating procedures.

WARNING

Propane gas is highly flammable. improper use may result in a fire or explosion leading to property damage, injury, and/or possible death.

5. Tire Pressure

ALWAYS check tire pressures **PRIOR TO** departing with your RV, even for short distances. For proper tire inflation pressures, refer to the Tire Information Label. The Tire Information label is located on the driver side of the unit, in front of the LP compartment, and typically above the Federal ID (VIN) tag. See [Section 5C\(4\)](#).

6. Towing

WARNING

RVs can sway and fishtail in high cross winds or when exposed to external forces created by large vehicles as they pass. If caution is not exercised, control of the RV and tow vehicle can be lost resulting in serious damage, injury, and/or death. Under such conditions, it is imperative to slow down and pay attention to other vehicles and your surroundings.

- **ALWAYS** follow posted speed limits.
- **ALWAYS** respond appropriately to weather and/or road conditions that may impact stability, handling, and towing of your RV and tow vehicle.
- **ALWAYS** be aware of your surroundings.

7. Wheel Torque

- **ALWAYS** check the torque on all lug nuts **PRIOR TO** departing on any trip, including short distances. For lug nut torque specifications and patterns, refer to the [Section 5K](#).
- **ALWAYS** use a calibrated torque wrench to confirm torque.

SEC.05 PRE-TRAVEL INFORMATION

A. GENERAL

Traveling can be stressful. To reduce stress, we recommend using updated maps or GPS navigation to ensure your route utilizes the most up to date information. Call ahead to obtain tourist information in the areas you will be visiting. To ensure safety, make sure your designated camping area and planned adventures comply with all federal, state, and local rules and regulations.

- While away from your home, have someone you trust periodically check on your residence. If you plan to travel for more than two (2) weeks, consider contacting your local police in advance to keep surveillance of your home.
- Carry secondary keys for vehicles and your house on a separate key ring to prevent them from being lost.
- Ensure your driver's license is updated and valid. Renew your license in advance if it will expire during your travels.
- If you plan on visiting other countries, be sure to contact the border control nearest to your planned point of entry to obtain current entry rules and regulations (including rules for re-entering the United States).

+ NOTICE

Always carry your vehicle registration, insurance policy card(s), and warranty registration.

B. TOW VEHICLE DISCLAIMER

Your tow vehicle's Towing Capacity **MUST BE GREATER** than the Gross Vehicle Weight Rating (GVWR) of your RV. If you do not know your Towing

Capacity or if you are considering purchasing a new tow vehicle, contact your automotive manufacturer or Dealer to obtain the towing specifications of the prospective vehicle(s). Be aware that some vehicles can be purchased with optional towing packages.

Some automotive manufacturers have brochures for their products that contain towing capabilities and specifications. This information should be reviewed to verify weight ratings and limitations. Make sure you are looking at your exact model, year, engine, transmission, etc. to ensure you are receiving accurate information.

+ NOTICE

Brinkley RV shall not be liable for any damages that may be incurred by the Customer, owner, or driver of a Brinkley RV as a result of the operation, use, and/or misuse of a tow vehicle.

C. VEHICLE LABELS

Throughout your RV, labels and data plates are present containing information pertaining to safe operation, service instruction, RV specifications, and warnings. Be sure to read all provided labels, decals, and data plates before operating your RV. If any label within your RV is damaged, painted over, or removed, they should be replaced right away.

1. Weight Ratings and Definitions

It is vital to remain within the weight rating specifications of your RV and tow vehicle. Failure to do so may result in loss of warranty, damage to your tow vehicle, or damage to your RV. More critically, failure to adhere to weight limitations poses great danger to you and those around you when operating or towing your RV. Vehicle and RV weights fall into two categories:

- **Ratings** are maximum limit thresholds that should **NEVER** be exceeded. These limits are established by Brinkley RV and our component manufacturers in the design of the RV.
- **Weight** and **Load** are often used interchangeably and refer to the actual weight of the RV. Weight or Load is measured by placing an RV, tow vehicle, or its components on a scale. Vehicles and added cargo add weight and affect the distribution of weight to the hitch, tires, and axles.

⚠ WARNING

Exceeding a rating may result in unsafe conditions, potential damage, may void warranty, may complicate an insurance claim, and in some cases, may violate applicable law.

⚠ WARNING

The volume of space available for storage may exceed the amount of available Cargo Capacity. Large storage compartments have been designed to accommodate normal camping items, which are bulky, but not necessarily heavy.

⚠ WARNING

The actual total weight of the RV, its options, holding tanks and contents, personal cargo, and hitch weight are important to know so that you **DO NOT** exceed the Gross Vehicle Weight Rating (GVWR) of the RV.

To better understand how to safely manage our RV's weight and balance, please see the weight-related definitions outlined below:

Gross Axle Weight Rating (GAWR)

Gross Axle Weight Rating (GAWR) is the maximum weight the axles are designed to carry.

Gross Vehicle Weight Rating (GVWR)

Gross Vehicle Weight Rating (GVWR) (also known as Maximum Load Capacity) includes the GAWR plus the hitch weight. GVWR is the maximum allowed weight your trailer is rated to carry. This weight includes the weight of the trailer itself and ANY cargo or equipment you intend to haul inside the RV.

Gross Vehicle/Trailer Weight (GVW or GW)

Gross Vehicle Weight (GVW) is the actual weight of the RV, including everything in or on the RV, and is established by measuring on a scale. This is the actual weight of the trailer fully loaded.

Gross Combined Weight Rating (GCWR)

The Gross Combined Weight Rating (GCWR) is the maximum allowable weight of a fully loaded towing vehicle and the weight of the fully loaded RV combined.

Gross Combined Weight (GCW)

Gross Combined Weight (GCW) is the actual weight of your fully loaded RV and tow vehicle combined, as measured on a scale.

Unloaded Vehicle Weight (UVW)

(or Dry Weight). Unloaded Vehicle Weight (UVW) or Dry Weight is the weight of the RV as it is built from the factory with no added water, fuel, propane, supplies, or passengers. This includes only the items installed at the factory and no aftermarket installations made by you, the Dealer, or any other entity.

Hitch Weight (HW) (or Tongue Weight)

Hitch Weight (HW) or Tongue Weight is the actual amount of weight that presses down on the hitch when the RV is connected to the towing vehicle.

Cargo Carrying Capacity (CCC)

Cargo Carrying Capacity (CCC) is the maximum weight of personal cargo that can be added to the RV.

- **In the United States:** CCC = GVWR –

SEC.05 PRE-TRAVEL INFORMATION

[UVW and LP gas weight]. Water is a component of the CCC.

- **In Canada:** CCC = GVWR – [UVW, LP gas weight, and full fresh (or potable) water weight (including the water heater)]. Water weight is not a component of the CCC.

2. Weight Labels

Vehicle weight labels are placed on every RV to ensure the owner and/or potential buyer is fully aware of this information. Proper weights and limitations are important to the use of your RV.

+ NOTICE

Do not remove these labels. If the labels are missing or damaged contact your Dealer or Brinkley RV Customer Care for replacement decals.

3. Federal Certification Label

The Federal Certification Label specifies the maximum capacities for GVWR, GAWR, and the tires. This is located on the driver’s side (also known as the off-door-side) towards the front of your RV. Typically, this label is located in front of the LP compartment.

Below is an example of the Federal Certification Level. Note that the information on your specific RV on this tag will vary from what is shown below:

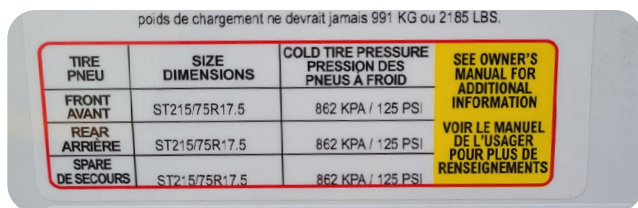

4. Tire and Loading Information Label

The Tire and Loading Information Label provides tire size information, recommended tire pressure(s), and the maximum amount of cargo that can be safely added to the RV. This label is located on the driver’s side (also known as the off-door-side) towards the front of your RV.

Typically, this label is located in front of the LP compartment. Below is an example of what the Tire and Loading Information looks like. The information contained on this tag may vary on your RV from what is shown below.

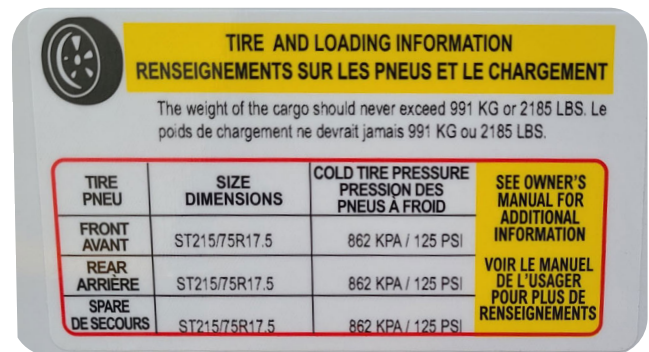

5. Cargo Carrying Capacity (CCC) Label

The Cargo Carrying Capacity Label specifies the maximum cargo carrying capacity for your RV. It is located on the outside of your RV on the edge of the main entry door.

An example label is provided below:

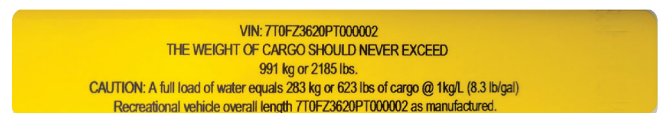

6. RV Length

a. Travel Trailers

The length of the RV is measured from the tip of the hitch coupler to the end of the rear most extremity of the RV.

b. Fifth Wheel Trailers

The length of the RV is measured from the most extreme front profile, commonly the tip of the pin box, to the end of the rear most extremity of the RV.

c. RV Overall Length Exclusions

The overall length of your RV excludes select accessories as defined by Brinkley RV, including but not limited to the following:

- Safety-related equipment such as signal, clearing, indication, warning lights.
- Appliance vent and vent hoods.
- Door latches and hinges.
- Entry and exit handles, grab bars, and/or railings.
- Exterior installed ladders.
- Spare tires, tire brackets, and/or carriers.
- Rear bumper.
- Outdoor cooking appliances.
- Towing hitch or cargo accessory receivers.
- Equipment or racks utilized to secure cargo.

D. CARGO CAPACITIES AND WEIGHTS

When loading your RV with cargo, **DO NOT** exceed any of the following:

- The maximum Cargo Carrying Capacity (CCC) noted on the Federal Tag.
- The Gross Vehicle Weight Rating (GVWR).
- The Maximum Load Rating of your RV tires.

⚠ WARNING

The load capacity of your RV is designated **by weight, not by volume**. All available storage space cannot necessarily be used when loading the RV. For the best possible handling:

- **DO NOT** exceed your GVWR.
- Ensure you are loading the vehicle evenly.
- Secure all loose or heavy items to prevent shifting during travel.

1. Maximum Load Rating

The Maximum Load Rating of your RV tires may be less than the GVWR. To calculate the load on your RV tires, subtract the hitch weight from the RV's Gross Weight or Total Weight. The hitch weight is carried by your tow vehicle, NOT the RV tires. Therefore, the hitch weight is subtracted.

EXAMPLE CALCULATION:

- Each RV tire is rated at 4,800 lbs., and there are 4 tires. 4 tires x 4,800 lbs. = 19,200 lbs.
- The Gross Vehicle Weight of the RV is 15,000 lbs. with a hitch weight of 1,300 lbs. \rightarrow 15,000 lbs. – 1,300 lbs. = 13,700 lbs. to be carried by the tires.
- In this example, the load distributed on the RV tires is 13,700 lbs. This is below the 19,200 lb. maximum tire load rating in the example.
- This figure should **ALWAYS** be under the maximum load rating of the tires. If it is not, you must remove weight from the RV to reduce the loading on the tires below the maximum tire load rating.

SEC.05 PRE-TRAVEL INFORMATION

2. Water and Propane (US ONLY)

- Fresh water is to be calculated as part of the Cargo Carrying Capacity Weight.
 - Water weighs approximately 8.3454 lbs. per gallon (1.0 kg per liter).
 - Based on this weight per gallon, a 50-gallon (189.271 liters) tank full of water will weigh roughly 417 lbs. (189.148 kg).

When nearing GVWR, try reducing the amount of water in the holding tank to lessen the water weight and to increase the amount of weight available for additional cargo needs. This will provide additional flexibility when making choices to match your travel and camping needs without compromising safety.

ALWAYS REMEMBER:

- The Unloaded Vehicle Weight (UVW) is calculated with empty LP bottles, holding tanks, and as built at the factory. Modifications are not included in the calculation.
- In the United States, Cargo Carrying Capacity is calculated including the weight of full LP bottles. $CCC = GVWR - (UVW + LP \text{ gas weight})$. Water is considered part of the cargo weight.
- In Canada, Cargo Carrying Capacity is calculated including the weight of full LP bottles and full freshwater tanks, including the water heater. $CCC = GVWR - [UVW + LP \text{ gas Weight} + \text{full fresh/potable water tanks (including the water heater)}]$.

For further questions, please contact your Dealer or Brinkley RV Customer Care.

3. Loading Your RV

When loading your trailer, it is critical that you understand the weight limitations of your RV and tow vehicle as well as the importance of maintaining a balanced load from side-to-side of the RV. [Section 5D\(4\)](#) below covers the weighing process in detail to help ensure that you properly load your RV prior to travel.

WARNING

ONLY store items in the areas designated for storage. DO NOT store anything in the areas reserved for the furnace, water heater, converter, electrical panels, and other appliances.

WARNING

During a sudden stop, free-standing furniture or overlooked items on the counter tops or shelves can become dangerous projectiles. It is important to secure the appliance or furniture with tie down straps (If Equipped or Customer Supplied). Be sure to store and secure all loose items inside your RV. Check that all items are safely put away **BEFORE** travel.

4. Weighing the Tow Vehicle and RV

a. In General

Total weight and **balance** of the RV are the two most important factors when loading your RV. It is important to **ALWAYS** follow and never exceed the weight rating limits specified for your RV. To ensure you are not exceeding your Gross Vehicle Weight Rating (GVWR) and other weight limitations, you should weigh your RV at a public scale or weigh station once your RV is fully loaded.

Utilizing a scale will also help to determine proper load distribution. To better ensure you are balancing load within your RV, it is best to use a weigh station that has separate scales to weigh the driver and passenger sides of the RV.

+ NOTICE

Individual scales and weight stations may operate differently. If you have any questions or concerns, do not hesitate to contact us. It is our priority to ensure you have the tools necessary to safely tow your RV.

b. Weighing Your Tow Vehicle and RV

It is important to read and understand the weighing instructions prior to attempting to weigh your RV. Understanding this information is vital to ensure your safety. When weighing your RV, it must be weighed fully loaded with all contents you intend to travel with (i.e., food, water, clothing, supplies, propane, fuel, etc.) to obtain an accurate measurement and to determine whether you are within the weight limitations provided.

⚠ WARNING

An RV that is overloaded or has an imbalanced load will adversely affect your tow vehicle's handling and braking capabilities. It can also lead to component failures that could leave you stranded on the side of the road. Overloading can affect your safety and the safety of those around you. It will also lead to voiding of any applicable warranties as overloading is considered a form of misuse.

⚠ WARNING

DO NOT EXCEED YOUR GVWR!

You should weigh the RV as loaded for your normal travel to determine the actual weight. If you exceed the GVWR, you **MUST** remove items from the RV, or drain liquids, then reweigh the RV to ensure you have achieved a safe weight below the stated GVWR. Also, **DO NOT** travel with full gray/black holding tanks as doing so negatively impacts fuel efficiencies and the towing and handling characteristics. It is also recommended that you **NOT** travel with a full fresh tank. You should plan to fill the fresh tank as close to your end destination as possible.

⚠ WARNING

NEVER load the RV more than the GAWR for either axle. Overloading the RV may result in adverse handling characteristics and damage to the RV chassis. Evenly distribute your cargo side-to-side for safe travel. The weight on each tire must not exceed one-half of the GAWR (Gross Axle Weight Rating) for either axle.

⚠ WARNING

Exceeding the established weight ratings for the axles, running gear, tires and wheels can lead to failure that can affect motor vehicle safety and lead to property damage or damage to the RV.

SEC.05 PRE-TRAVEL INFORMATION

PROPER WEIGHING PROCEDURE:

1. GROSS VEHICLE WEIGHT CALCULATION—

Weigh your RV while unhitched from the tow vehicle to obtain your Gross Vehicle Weight (GVW). Be sure to pull the tow vehicle far enough away such that it is not included in the weight calculation. You will also have to lower the landing gear (fifth wheel) or tongue jack (travel trailer) to obtain the weight measurement.

- a. For safe operation, your Brinkley RV's Gross Vehicle Weight (GVW) **MUST** be less than or equal to the Gross Vehicle Weight Rating (GVWR).
- b. If your Brinkley RV's GVW is greater than the GVWR, you **MUST** remove contents until the GVW is less than your Brinkley RV's listed weight ratings.

2. GROSS COMBINED WEIGHT CALCULATION

Hitch your RV to the tow vehicle.

Weigh the RV and tow vehicle to obtain your Gross Combined Weight (GCW).

- a. Confirm that your **GCW is less than, or equal to the GCWR** specified by the manufacturer of your tow vehicle.
- b. If your **GCW is greater than the GCWR**, remove contents until the weight is less than the GCWR.

3. HITCH WEIGHT CALCULATION

While still hitched to the tow vehicle, pull onto the scale to weigh only the RV, and record that weight. This measures the total load carried by the RV tires. This weight, when subtracted from the GVW, is your Hitch Weight.

4. BALANCED WEIGHT CALCULATIONS

To obtain the side-to-side weights of the RV, there must be ample room on either side of the scale to accommodate the RV being partially off the scale.

- a. Pull the RV so that the tires of only one side of the RV are on the scale. The RV must remain as level as possible in order to obtain an accurate weight measurement.
- b. **For a balanced load:** The weight of one side of your RV, must be equal to one half (1/2) of the total weight on the tires that you measured in step 3 above. If this is not the case, then you must redistribute the load until the RV is equally balanced side-to-side.

If you have questions or concerns, please consult with your Dealer, scale operator, or Brinkley Customer Care for additional assistance.

WARNING

The total weight of your tow vehicle and RV must not exceed the GCWR. **NEVER** assume that you can tow an RV that happens to be within the capacity of the tow vehicle hitch. By doing so, you may exceed the total GCWR.

WARNING

It is important to redistribute the load to avoid component failure as well as to improve the handling characteristics of the vehicle. When a load is unbalanced, the components located on the heavier side of the RV (the wheels, brakes, springs, axle hangers, tires, etc.) may be overloaded, even though the total axle load is within the limits imposed by the GAWR.

E. TIRE SAFETY INFORMATION

1. Introduction

This section of the Owner's Manual contains tire safety information as required by 49 CFR 575.6(4) and is based in part on the National Highway Traffic Safety Administration's (NHTSA) brochure entitled "Tire Safety, Everything Rides On It." This brochure is available as a free download on the NHTSA website:

<https://one.nhtsa.gov/Vehicle-Safety/Tires/Tire-Safety-Everything-Rides-On-It>.

Tire safety studies show that the most important things you can do to avoid tire failure, blowouts and flat tires are as follows:

- **ALWAYS** maintain proper tire pressures.
- **OBSERVE** and adhere to tire and vehicle Load Limits. **NEVER** carry more weight in your vehicle than your tires or vehicle can safely handle.
- **AVOID** road hazards.
- **DRIVE** within the designated tire speed ratings.
- **INSPECT** tires for slashes, cuts, marks, and other irregularities.

These actions, along with other care and maintenance activities, can also:

- Improve vehicle handling.
- Improve stopping distance.
- Increase traction.
- Improve overall fuel economy.
- Help protect you and others from avoidable and/or preventable breakdowns and accidents.
- Increase the life of your tires.

Make tire safety a regular part of your vehicle maintenance routine. Know that the time you spend on tire safety and maintenance is minimal compared to the inconvenience and safety consequences of a flat tire or other tire failure.

2. Maximum Load Rating

The Maximum Load Rating indicates the maximum load in pounds (or kilograms) that can be safely carried by the tire.

3. Maximum Inflation Pressure

The Maximum Permissible Inflation Pressure is the greatest amount of air pressure that the tire should ever be inflated to under normal driving conditions.

4. Recommended Tire Pressure and Load Limit

WARNING

Under-inflated tires and overloaded vehicles are major causes of tire failure.

Tire information placards and vehicle certification labels provide important information regarding tires, weights, and load limits, including the following:

- The recommended tire size.
- The recommended tire inflation pressure.
- The Cargo Carrying Capacity (CCC).
- The front and rear Gross Axle Weight Ratings (GAWR).

For definitions and information regarding labels see [Section 5C](#).

5. Understanding Tire Pressure and Load Limits

Load Limits are determined by the tire size and the maximum amount of weight each tire can safely carry.

Tire Pressure is the amount of air pressure a tire requires to achieve proper inflation. It is measured in pounds per square inch (PSI) or kilopascals (kPa). Tire pressure affects your RV's overall performance and provides the load-carrying capacity.

SEC.05 PRE-TRAVEL INFORMATION

On the Tire and Loading Information Label, the proper tire pressure for your vehicle is listed as Cold Tire Pressure. You will find this number expressed in both PSI and kPa.

⚠ WARNING

Always check tire pressure when tires are cold. Cold tire inflation pressure is defined as a tire that has not been used for three or more hours or has been driven less than one mile prior to the pressure measurement. Note that a hot tire may increase the tire inflation pressure by as much as six (6) PSI (41.4 kPa) over a cold tire. DO NOT exceed the maximum recommended pressure.

+ NOTICE

The axle and wheel assembly on your RV is designed and manufactured much differently than that of an automobile. The overall size, weight, and balance of your RV exposes the wheels to pressures that are unique to trailering. When turning, or cornering, the wheels and tires experience a considerable amount of stress known as “side loading.”

6. Checking Tire Pressure

a. Frequency

It is important to check the cold inflation pressure of your RV's tires at least monthly since:

- Most tires will lose air pressure naturally over time, particularly when the outdoor temperatures fluctuate.
- Tires can suddenly lose air after driving over a pothole, hitting road debris, or striking a curb.
- With radial tires, it is generally not possible to visually determine if a tire is under-inflated.

+ NOTICE

For safety and convenience, you should always keep a Tire Pressure Gauge in your vehicle.

b. Maintaining Proper Tire Pressure

TIRE PRESSURE:

1. The recommended cold inflation pressure is listed on the Tire and Loading Information label located on the off-door-side, forward exterior of your RV. You should first locate this label to ensure that you know the recommended cold inflation pressure of each tire.
2. Use a Tire Pressure Gauge (Customer Supplied), to check the tire pressure of every tire:
 - a. If the tire pressure is above the maximum inflation pressure in any of the tires, gently press on the tire valve stem release valve with the edge of your tire gauge. Slowly release air until the correct pressure is obtained.
 - b. If the tire pressure is below the recommended cold inflation pressure in any of the tires, immediately add air to any underinflated tires.
3. At a service station or otherwise utilizing an air compressor, add air to each under-inflated tire until the correct cold inflation pressure is reached.
DO NOT OVER-INFLATE.
4. Re-check the RV tires with the Tire Pressure Gauge. Confirm that all tires are at the same recommended cold inflation pressure. Make any additional adjustments as needed.

⚠ WARNING

If the total weight of the RV (GVW) exceeds the GVWR, the RV is overloaded. Operating your RV while exceeding the specified weight ratings increases the risk of a crash, personal injury and death. It is imperative that you remove cargo (equipment, water, personal belongings, etc.) until the total weight of the RV no longer exceeds the GVWR before operating the RV.

⚠ WARNING

Although it is ideal to check and fill tire pressures when the tires are cold, if you discover a tire on your RV that is underinflated, even if the tires are warm, add air until the recommended cold inflation pressure is reached. The warm tire may remain slightly underinflated, but this is much safer than driving with a significantly underinflated tire. **REMEMBER** to recheck and adjust the tire pressure(s) as soon as a cold tire pressure reading can be obtained to ensure proper inflation.

7. The Effect of Overloading Your RV and Tires

Overloading your RV and/or tow vehicle's suspension system can cause spring, axle, shock, chassis damage and/or brake failures. Overloading your RV can increase stopping distances, create handling and/or steering problems or difficulties, cause irregular tire wear, blow-outs, tire failure, and/or other damage to the RV and/or tow vehicle.

And, in cases of excessive overloading, RV brakes are at risk of failing completely, particularly on steep declines when the weight of the RV applies additional stress to the brake system.

Tire overloading caused by exceeding Cargo Carrying Capacity and/or improper inflation of tires may result in abnormal flexing, wear, and tear of the tire. Abnormal tire flexing can cause an excessive amount of heat to generate within the tire. This should be avoided at all costs. Failure to do so may result in fire and/or damage to tire assembly and/or RV.

⚠ DANGER

EXCESSIVE HEAT MAY LEAD TO TIRE FAILURE. PROPER INFLATION IS CRITICAL. It is the air pressure that enables a tire to support the load.

⚠ DANGER

Overloading your RV can have serious consequences for passenger safety. An overloaded vehicle is generally harder to drive and more difficult to stop. Excessive overloading may also cause brakes to fail completely.

⚠ DANGER

If the weight on the trailer axles exceeds the GAWR, the axles are overloaded. Operating your RV while exceeding the specified weight ratings increases the risk of a crash, personal injury, and death. It is imperative that you remove or rearrange cargo (equipment, personal belongings, water, etc.) until the axle weight no longer exceeds the GAWR before operating the unit. Not operating your RV within the designed weight ratings can damage your recreational vehicle and can void the warranties.

SEC.05 PRE-TRAVEL INFORMATION

8. Proper Tire Load Limits

Tire size, load range, and corresponding inflation pressure all determine the load a tire can safely carry. The required air pressure for RV tires must be determined by the actual load of the RV and taken from the Load and Inflation Tables provided on the tire manufacturer's website (See [Section 5D\(4\)](#) above for weighing instructions).

- The air pressures recommended on tire manufacturing websites may differ from those provided on the certification label of your RV.
- RV weight and/or tire pressure should never exceed the tire's stated Maximum Load Rating or maximum air pressure.
- If you discover that your tires cannot support your RV's weight, REMOVE enough cargo until the RV's weight is within the stated limits.

To determine the correct cargo load limit:

- Locate the statement "The weight of cargo should **never exceed** XXX KG or XXX LBS" on your RV's Cargo Carrying Capacity label. See [Section 5C\(5\)](#) for information on the CCC label.
- The Cargo Carrying Capacity is the available load capacity for cargo and luggage (See [Section 5E](#) above for full details and definitions). The combined weight of cargo and luggage loaded on your RV must not exceed the Cargo Carrying Capacity.

9. Tire Safety Tips

Preventing tire damage

- **DO NOT** run over curbs, potholes or foreign objects in roadways, campsites, or when parking.
- **SLOW WAY DOWN** if you cannot avoid a pothole, animal, or any other object in the road.

TIRE SAFETY CHECKLIST:

1. **CHECK** all tire pressures prior to every trip, including any spare tires.
2. **INSPECT** all tires for uneven wear **patterns**, cracks, foreign objects, or any other damage.
3. **Carefully REMOVE** bits of glass or foreign objects wedged in the tread.
4. **CHECK** that the valve caps are **on the tire valve stems**.
5. **CHECK** the wheel torque prior to each trip. See [Section 5J](#).
6. **DO NOT** overload your vehicle.

+ NOTICE

FOLLOW the instructions for cargo and cold tire pressure found on your Tire and Loading Information label.

10. Tire Labeling

Federal law requires that tire manufacturers provide standardized information molded into the sidewall of all tires sold in the United States. This information includes:

- Tire size.
- Construction.
- Various capacities (max. pressure, load, speed).
- Tire Identification Number.

US DOT TIRE IDENTIFICATION NUMBER (TIN):

The Tire Identification Number is provided for safety standard certification and in the event of a recall. This identification is considered the tire's serial number and provides specific production details to the tire.

- The TIN begins with "DOT" and is usually followed by 10-12 numbers, letters, and symbols.
- The first two (2) numbers or letters following DOT, signify the plant in which the tire was manufactured.
- The last four (4) numbers signify the week and year the tire was built (i.e., 2123 = the 21st week of 2023).
- The remaining characters in the TIN are codes used at the tire manufacturer's discretion and vary by supplier.

11. Tire Size and Type Designation

The tire specifications are located on the Tire and Loading Information label or on the sidewall of the tire that you are replacing. As an example, the tires on your RV at the time of publication of this Owner's Manual are marked with a designation of:

Coding Break Down

- The first three (3) digit number (215 in the example above) provides the tire width in millimeters measured from sidewall edge to sidewall edge.
- The next two (2) digit number after the "slash" mark (75 in the example above), provides the tire height to width ratio of the tire. This is also referred to as the aspect ratio.
- The "R" stands for radial.
- The last three (3) digit numbers (17.5 in the example below) is the diameter in inches of the wheel.
- Finally, "HRT" means that the tire is H rated. The rating dictates the maximum speed of the tire. In this case, the maximum speed for an H rated RV tire is 75 miles per hour (mph) (120 kilometers per hour (kph)).

DO NOT exceed the Speed Rating regardless of the posted maximum speed limit.

For further information, please contact a tire Dealer, Brinkley RV Customer Service, or refer to the full tire sidewall diagram referred to on the next page.



SEC.05 PRE-TRAVEL INFORMATION

GET TO KNOW YOUR TIRE SIDEWALL

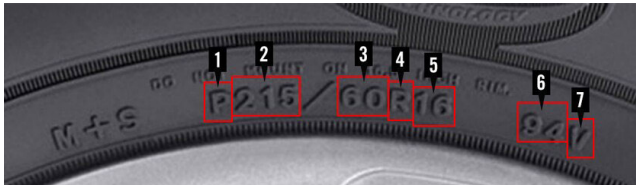

The numbers and letters representing your tire size do have meaning. Learn how to read a tire sidewall and find what the numbers on a tire mean using the detail below.

1. Metric or Tire Type. The metric, or tire type, defines the proper use of the tire. For example, a “P” designation means that it is a passenger car tire. An “LT” designation is for a light truck. No letter before the width indicates that it is a European metric tire.

2. Tire Width. The width of the tire measured in mm from sidewall to sidewall. In the example above, the tire width is 215 mm.

3. Aspect Ratio. The aspect ratio is the ratio of the height of the tire’s cross-section to its width. On our example, 60 means that the height is equal to 60% of the tire’s width.

4. Construction. The construction letter tells you how the layers of the tire were put together. “R” stands for radial, which means the layers run radially across the tire. “B” stands for bias construction, which means that the layers run diagonally across the tire.

5. Rim Diameter. The rim diameter is the width in inches or cm of the wheel from one end to the other. The diameter of this wheel is 16 in. Always replace a tire on a rim with another tire of exactly the same rim diameter designation and suffix letters.

6. Load Index. The load index is an assigned number that corresponds with the load-carrying capacity of a tire. Most passenger car tire load indexes range from 75 to 100, but a few carry more. You’ll also find the maximum load elsewhere on the tire sidewall, both in lbs. and kg. Learn more about tire load index.

7. Speed Rating. The speed rating tells you the maximum service speed for a tire. A speed rating isn’t, however, a recommendation to exceed speed limits, and doesn’t indicate how well a tire handles or corners. Learn more about tire speed rating. (**Source: Goodyear Tire and Rubber**)

F. TIRE TREAD







The tread of the tires is what provides frictional force, water evacuation, and traction that prevents your RV and vehicle from slipping and sliding. The frictional force also assists in slowing the RV or vehicle down within acceptable stopping distances. This is particularly important when the road conditions are wet, snowy or ice covered. Tires with 1/16” or less tread depth are not safe and should be replaced.

Tread wear beads are raised sections built into the bottom of a tire’s treads to show how much tread remains. When your tread wear beads appear to be even with the outside of the tread, it is an indicator that it is time to replace your tires. There are also gauges utilized by service centers to measure the remaining tread depth. Please refer to the picture shown below and right for additional detail.

Inspect your tires regularly for uneven tread wear. Uneven tire wear is an indication of imbalanced loads, over or under-inflated tires, wheel balance, or other misalignments. The sooner the cause of the uneven tread wear is remedied, the better. Replacing tires can be an expensive endeavor.

For your ease of reference, the table below shows the various forms of uneven tire wear and their likely cause:

TIRE WEAR DIAGNOSTIC CHART

WEAR PATTERN	CAUSE	ACTION	
	CENTER WEAR	OVER INFLATION	ADJUST PRESSURE TO PARTICULAR LOAD PER TIRE CATALOG
	EDGE WEAR	UNDER INFLATION	ADJUST PRESSURE TO PARTICULAR LOAD PER TIRE CATALOG
	SIDE WEAR	LOSS OF CAMBER OR OVERLOADING	MAKE SURE LOAD DOESN'T EXCEED AXLE RATING . ALIGN AT ALIGNMENT SHOP.
	TOE WEAR	INCORRECT TOE-IN	ALIGN AT ALIGNMENT SHOP
	CUPPING	OUT-OF-BALANCE	CHECK BEARING ADJUSTMENTS AND BALANCE TIRES
	FLAT SPOTS	WHEEL LOCKUP & TIRE SKIDDING	AVOID SUDDEN STOPS WHEN POSSIBLE AND ADJUST BRAKES

G. TIRE PLY COMPOSITION AND MATERIALS

Tires are constructed from multiple layers of rubber coated fabrics. Each layer is referred to as a ply. In general, the higher the number of plies in a tire, the more weight it can support.

Tire manufacturers must report all materials used in the composition of their tires, (steel, nylon, polyester, etc.). To the right is a typical picture of the anatomy of a typical Cooper radial tire.

H. SPARE TIRE

The spare tire is utilized for instances where an RV tire is damaged, flat, or otherwise fails to maintain air pressure.



SEC.05 PRE-TRAVEL INFORMATION

⚠ WARNING

The spare tire and wheel may differ from the original equipment. The spare tire is only intended for temporary use. Please refer to the tire specifications on the sidewall of the spare tire for additional information and to ensure your safety.

The spare tire is secured below your RV. Locate the 1" access hole in the skirt metal on the door-side of your RV, approximately even with the spare tire. The photo below shows the location of the 1" access hole. The second photo below shows the location of the access hole relative to the spare tire location.

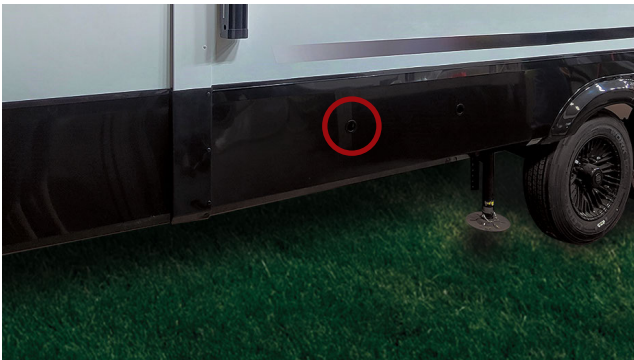

- Insert the crank handle extension.
- Turn the crank handle **counterclockwise** to lower the spare tire.
- Turn the crank handle **clockwise** to raise the spare tire.

I. TIRE CHANGING BASICS

Use a hydraulic jack and jack stands (both items Customer Supplied) when changing a tire. Below are generalized instructions on changing an RV tire.

CHANGING THE TIRE:

1. Before beginning, block the wheels on the opposing side of the tire in need of being changed. This will prevent accidental movement while changing the tire and is vital to ensure safety.
2. Before lifting the RV with a hydraulic jack (Customer Supplied), loosen the wheel lugs on the tire.
3. Place the hydraulic jack on the I-beam of the RV frame and close to the spring hanger. Slowly lift the RV until the tire is hovering an inch or two above the ground.
4. Place a jack stand under the RV frame just behind the tire being changed. The jack stand serves as a safety measure to prevent the RV from falling if the hydraulic jack moves or fails to hold the weight of the RV.
5. Once fully stabilized, continue in changing the tire and follow the wheel nut torque specifications.

⚠ WARNING

NEVER use a stabilizer jack or the leveling system to lift the RV. The stabilizer and level jacks are not intended to lift the unit off the ground. Utilizing these jacks to change a tire could result in injury, property damage, voiding a warranty, or death.

⚠ WARNING

Before you climb or crawl underneath the RV, both the front and rear axles should be supported with jack stands. Failure to do so may result in serious injury, property damage, or death.

J. WHEEL NUT TORQUE

The torque of the wheel lug nuts must be maintained and inspected on a continuous basis. Torque measures the tightness of a lug nut or the rotational force and is measured in foot-pounds (ft-lbs.) or Newton meters (Nm). When checking torque, please follow the instructions below.

- **ALWAYS** properly calibrate the torque wrench prior to use.

- **NEVER** use a torque wrench that is worn out or damaged.
- **ALWAYS** check every lug nut's torque prior to departure. Regardless of how short the trip may be, proper lug nut torque is imperative to ensure your safety.
- **DO NOT** under or over-torque any lug nut. Under and over-torque can be dangerous and may cause damage or failure.
- **ALWAYS** tighten lug nuts with the correct lug pattern shown in the diagram below.

Tire Installation:

Once the wheel and tire are removed, and the wheel and tire assembly are mounted, start by hand tightening all lug nuts until snug and then tighten per the below stages.

- **1st Stage** – Tighten all lugs to 20-25 ft. lbs. of torque.
- **2nd Stage** – Tighten to 50% of the final torque specification.
- **3rd Stage** – Tighten to stated final torque specification.

Determine the correct torque for each stage and use the Final Torque Specification Table shown below.

:

WHEEL TORQUE SPECIFICATION TABLE

STUD SIZE	LUG NUT TYPE	FINAL TORQUE SPECIFICATIONS	WHEEL SIZE	WHEEL MATERIAL
1/2"	CONED	90-120 FT-LBS. [122-162.7NM]	14"/15"/16"	STEEL
9/16"	CONED	120-140 FT-LBS. [162.7-189.8NM]	16"	STEEL
1/2"	CONED	110-120 FT-LBS. [149.1-189.8 NM]	14"/15"/16"	ALUMINUM
9/16"	CONED	125-130 FT-LBS. [169.5-176.3 NM]	16"	ALUMINUM
9/16"	CONED	125-130 FT-LBS. [169.5-176.3 NM]	17.5"	ALUMINUM

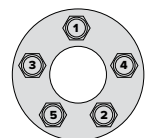

5-LUG PATTERN

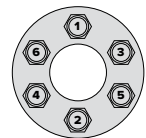

6-LUG PATTERN

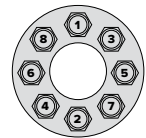

8-LUG PATTERN

SEC.05 PRE-TRAVEL INFORMATION

⚠ WARNING

Always torque the wheel lug nuts to the specifications provided by the wheel manufacturer. Over and under-torqued wheel lug nuts can cause the wheel to separate from the mounting surface during transport, causing property damage, personal injury, or death.

+ NOTICE

Lug nuts on the RV wheels require frequent torque maintenance. Torque measures the tightness of a lug nut or the rotational force and is measured foot-pounds (ft-lbs.) or Newton meters (Nm).

K. TIRE WARRANTY

Tires are warranted by the Tire Manufacturer, not by Brinkley RV directly. If you require tire warranty assistance, please refer to the tire warranty information provided in the Owner Information Package and in Section 4 of the provided Warranty Guide. Note that you can always contact your selling Dealer or Brinkley Customer Care for further assistance.

L. ROADSIDE EMERGENCY

A roadside emergency can occur at any given time. **ALWAYS** carry an emergency travel kit (Customer Supplied) with three red warning flags, flares, or cones to display if necessary.

In case of an emergency roadside stop:

- Pull off the side of the road as far as possible ensuring you are away from traffic.
- Turn ON the vehicle and trailer hazard lights to alert other drivers to pass with caution.
- Place the three (3) warning indicators (flares, signs, flags, reflectors, cones, lanterns, etc.) as follows:

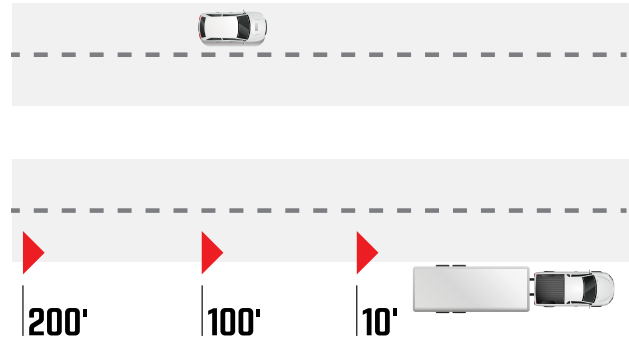

1st indicator: 10 feet behind the RV driver's side also referred to as off-door-side.

2nd indicator: 100 feet behind the RV in the center of the lane in which you are in.

3rd indicator: 200 feet behind the RV in the center of the lane in which you are in.

- Address the emergency promptly and as cautiously as possible.

+ NOTICE

Curves and/or elevation changes in the roadway may affect the safe placement of warning indicators. Please plan to make adjustments to their placement as necessary. The purpose of the warning indicators is to provide a warning to others and for your own safety. Use common sense with this goal in mind to guide proper placement.

+ NOTICE

If roadside assistance is needed, please contact SafeRide. This roadside assistance program is provided to you free of charge for the first year of ownership. Their contact information can be found at the bottom of every page. This service is provided by Brinkley RV for the first twelve (12) months of ownership of a new Brinkley RV.

A. RECOMMENDED SAFETY

To improve safety and to help protect against injury, follow the below recommendations:

- **ALWAYS** keep tires properly inflated and replace worn tires as needed on the RV and tow vehicle. Do not wait until they are excessively worn.
- **ALWAYS** obey all traffic laws and wear your seatbelt.
- **DO NOT** exceed the posted roadway speed limit.
- Follow lowered speed limits for tow vehicle and RV combinations.
- **ALWAYS** be alert and considerate while driving.
 - Be observant of other drivers, motorcyclists, bicyclists, and pedestrians.
 - Be vigilant to possible traffic and road conditions.
 - Prior to merging or changing lanes, check all mirrors for other vehicles, use a turn signal, and merge with caution.
 - Account for sudden braking and other possible unexpected events.
- **ALWAYS** operate daytime running lights on your tow vehicle to increase visibility to other drivers.
- **NEVER** drive when drowsy or tired, especially at nighttime.
- **NEVER** drive under the influence of drugs, alcohol, or medications that may impair your reflexes, alertness, or judgment.
- **ALWAYS** be aware that weather conditions and extreme terrain may affect your tow vehicle and RV performance and handling.
- **NEVER** use cruise control when roads may be wet, icy, winding, or any other traffic situations that may require rapid response and sudden reductions in speed.

- **ALWAYS** before operating a cellular device while towing your RV, be sure to know the local laws, and understand the dangers using your cellular device poses. Even if local laws permit using cellular devices while towing, you should only do so when parked, stopped at a travel signal, or otherwise not in motion. Distracted driving can be as dangerous as driving under the influence.

- **NEVER** leave children or pets unsupervised in, or around the RV. Even children confined in child restraint systems (i.e., pack-n-plays, car seats, walkers, bouncers, swings, etc.) should be supervised to ensure safety.

Propane Safety

- **ALWAYS** shut off ALL propane appliances and turn off and secure LP tanks PRIOR to traveling. If driving with the LP system on or open, the level of danger will increase substantially in the event of a fire or accident.

WARNING

Utilizing a cellular device while driving, puts you and all other passengers at greater risk of accidents, injury, or even death. Distracted driving can be as or more dangerous than driving while intoxicated.

WARNING

Children and pets should be supervised at all times to ensure their safety remains your number one priority.

B. RV DRIVING SCHOOLS AND SEMINARS

If you have any concerns about towing your RV, consult an expert for tow driving education. There are many RV owner organizations and training facilities that offer tow driving classes and seminars. Brinkley RV is not affiliated with any of these locations or services. To obtain additional information and schedules you must

SEC.06 TOWING & LEVELING

contact the provider directly. Many can be found online, through RV publications, or at various RV campgrounds.

Be cautious when using websites and social media as a research tool. Always verify the information through various sites and always try to use accredited, reliable sources in the RV industry. Always make sure the information you are researching pertains to RVs. If you have any doubts or additional concerns, contact your Dealer or Brinkley RV Customer Care for assistance.

C. RV BRAKING SYSTEM

1. General

To maintain proper use and performance of your RV brakes, they must be used in combination with the brakes of your towing vehicle. RV brakes are designed to work alongside the brakes of your towing vehicle and should not be operated separately. If separately used, the brake system will experience accelerated wear, tear, and damage. Additionally, using only the trailer brakes can result in overheating that causes damage to the brake components and could potentially lead to a fire.

Brake Control System Components:

- Brake controller (Customer Supplied).
- Wire harness and connectors.
- Towing 7-way plug.
- Auxiliary batteries (see Section 8) (If Equipped or Customer Supplied).
- Breakaway switch.

2. Brake Controller

A brake controller (Customer Supplied) is highly recommended to assist in the functionality of your brake system. It is installed within your tow vehicle and will assist you in adjusting the sensitivity of the brakes. Please consult with your Dealer or the

supplier of the brake controller directly to decide which brake controller is best for your RV and tow vehicle combination. You should also be sure to learn how to properly set and utilize the brake controller as recommended by the brake controller manufacturer.

D. 7-WAY HARNESS TOWING CONNECTOR PLUG

The 7-way wire harness, also known as the towing connector plug, is a wiring harness that, when connected from the tow vehicle to the RV, will supply limited power to the RV. This limited power source is supplied to the RV brakes, clearance lights, running lights, turn signals, brake lights, etc.

Maintenance

Due to weather and environmental elements, corrosion may form on the 7-way connector.

CLEAN the connector plug before every use to ensure proper electrical contact. **INSPECT** the connector plug frequently to ensure no cracking or additional wear has compromised the housing on the plug that may further expose the wires to the elements as you travel. **REPLACE** if cracked, broken, or damaged.



⚠ WARNING

If the towing connector plug is damaged, you must replace it immediately. A failure to replace the towing connector plug when damaged may result in an electrical short leading to accidents, damage, fire, injury, and/or death. The connector plug provides all safety related lighting as well as power to your RV brakes.

E. BREAKAWAY SWITCH

On every RV, a breakaway switch is installed to ensure that if the RV becomes disconnected from the tow vehicle, the RV brakes will engage. The breakaway switch for your travel trailer is located on the A-frame of the RV. The breakaway switch is a crucial part of the RV braking system and should NEVER be removed. If the RV becomes disconnected from the tow vehicle, the cable from the breakaway pulls the pin from the switch and engages the RV brakes.



- **ALWAYS** secure the breakaway switch cable to a permanent location on the tow vehicle when hitching the RV.
- **ALWAYS** ensure the auxiliary battery (If Equipped or Customer Supplied) is correctly installed, and fully charged PRIOR to departing.

⚠ WARNING

The breakaway switch will only operate when it is supplied with power from an auxiliary battery (Customer Supplied or If Equipped). If you fail to install an auxiliary battery, there will not be power at the breakaway. This could lead to a catastrophic accident resulting in damage, injury and/or death.

⚠ WARNING

NEVER utilize the RV's brakes or breakaway switch as a parking brake. When the RV brakes are engaged, they are energized and draw power from the converter and auxiliary battery (Customer Supplied). This form of misuse can lead to damage to the brakes, wiring, connectors, and breakaway switch and could lead to a fire.

⚠ WARNING

Always ensure that the breakaway switch cable is long enough to accommodate making tight turns. Failing to ensure the cable is long enough may result in the breakaway pin being pulled and engaging the RV Brakes. Such an occurrence may lead to significant damage or could cause a fire.

⚠ WARNING

Any damage to the breakaway switch (box, cable, key, or wiring) requires a full replacement. This should NOT be repaired.

SEC.06 TOWING & LEVELING

E. BREAKAWAY SWITCH

+ NOTICE

The Coupler (TT) that is provided at the time of purchase of your RV is specifically designed to work with your RV. It is critical that, if you decide to replace or upgrade your pin box, that you select a version that is compatible with and approved for use with your particular RV.

SAFETY BREAK-AWAY SWITCH WILL NOT OPERATE

unless connected to a power source equivalent to or greater than an automotive type 12 volt, 12 amp hour wet-cell battery

⚠ WARNING

Utilizing a hitch receiver that is not designed for your particular RV application may result in catastrophic damage, injury and/or death. Further, utilization of an incompatible or unapproved pin box may void your warranty.

2. Travel Trailer Coupler

Travel Trailers use a ball style hitch that locks onto the hitch ball automatically as the trailer coupler is lowered onto the ball. The lever on top of the hitch will raise and drop as the hitch locks into place.

To release the trailer from the tow vehicle, pull the lever on top of the coupler upward until it is locked in the upright position and raise the trailer

⚠ WARNING

Always use safety chains when towing a trailer! Safety chains catch the trailers coupler should the hitch become disconnected. Failure to do so could result in injury or death.

Demco EZ-Latch:

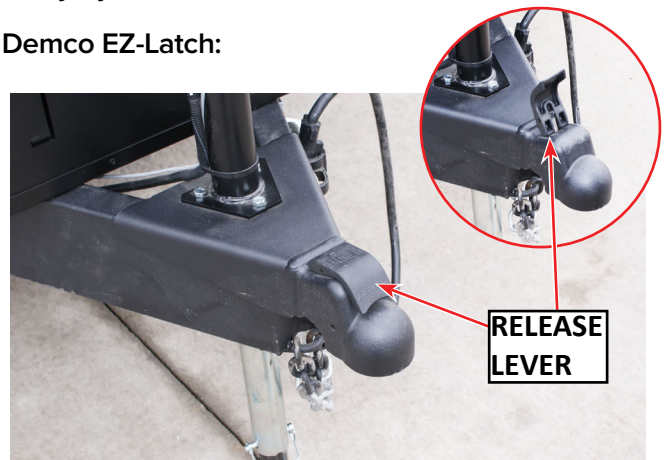

Parts of a Trailer Hitch Diagram

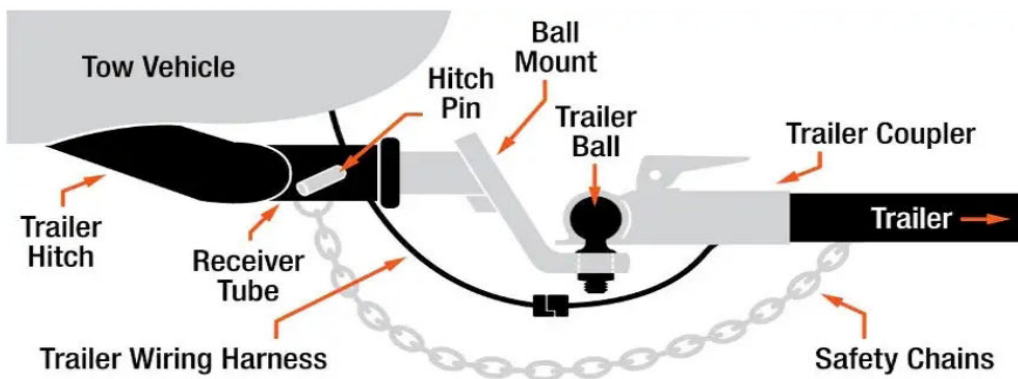

⚠ WARNING

NEVER climb under the RV while it is being towed, lifted, or leveled.

⚠ WARNING

Failing to follow to above-described hitching steps may lead to property damage, injury and/or death. Further, failing to retract the front jack(s) can lead to substantial damage to the jacks, your tow vehicle, and/or the RV.

5. TRAVEL TRAILER HITCHING PROCEDURE

1. **Ensure** your tow vehicle and RV are parked on a level and sturdy surface will ensure a solid king pin connection and make it easier to back your tow vehicle up to the RV.
2. **ALWAYS** use wheel chocks on both rear RV tires to prevent the RV from moving.
3. **ENSURE** the trailer coupler latch is open.
4. **RAISE** the trailer coupler with the front jack to a height 6" above the ball hitch on the tow vehicle.
5. **BACK UP** the tow vehicle until the hitch is under the coupler. Stop the tow vehicle and place it in park.
6. **LOWER** front of the trailer until the coupler has engaged the ball on the hitch. **BE CERTAIN** the coupler latches securely onto the ball.
7. **CROSS** the safety chains underneath the hitch and coupler with enough slack to allow turning and to hold the tongue up if the trailer comes loose. Connect and fasten the chains to the tow vehicle. Make sure the chains are secure before you move your tow vehicle and trailer.

⚠ WARNING

Always use safety chains when towing a trailer! Safety chains catch the trailers coupler should the hitch become disconnected. Failure to do so could result in injury or death.



G. TOWING THE RV

+ NOTICE

NEVER allow passengers to ride inside a towable RV while it is in motion. Towable RVs are not designed for occupants during transit and there are no safety or seat belts provided inside your RV. Further, it is against the law in many states for a towable RV to have occupants while in transit.

1. Braking and Stopping Distance

When towing an RV, be sure to allow for greater stopping distances. Before towing the RV, it is best to practice braking and stopping in a large parking lot (where allowed). This will allow you to become familiar with the RV brake system and practice braking with your RV before driving in traffic. Your RV is a substantial amount of weight behind your tow vehicle, and it is imperative that you are comfortable with the additional distances required to safely stop.

- **AVOID** road conditions and situations that may require excessive and/or prolonged use of the RV brakes.

SEC.06 TOWING & LEVELING

- Easing into a stop will increase the longevity of the brake life of your RV and tow vehicle. Failure to do so will result in additional wear and tear to the brake systems on both your RV and tow vehicle.

While descending a steep elevation, place the tow vehicle into a lower gear or lower gear range if your tow vehicle has an automatic transmission. This will allow the engine and transmission of the tow vehicle to help regulate the speed of the vehicle itself and in return extend the life of the brakes.

- Engage then release the brakes in short intervals to allow for cooling.
- When driving in or through deep water, be prepared to increase stopping distances and be aware that wet brakes may cause the vehicle or trailer to pull towards one side or the other.
- If you notice the brakes diminish in effectiveness or are not operating as efficiently, **DO NOT** continue towing the RV until the brakes are properly inspected and replaced as needed.
- **ALWAYS** check the brake operation of the RV in a safe environment before traveling to ensure proper operation.

2. Weight and Clearance Limits

It is important to know the dimensions of the RV, as well as the Combined Gross Weight of the RV and tow vehicle before traveling. This information is vital to ensure all posted Weight and Clearance Limits are properly followed.

- Remember that the RV height must include the roof air conditioners, TV antennas, solar panels, and floodlights for these may cause clearance complications under some tunnels, canopies, bridges, and/or hanging signs.
- Some bridges, particularly aged ones, may not support the weight of your RV combined with the weight of the tow vehicle.

3. Road Conditions

Adjust driving accordingly to the road and environmental conditions.

- Slow down, then release the brakes prior to crossing railroad tracks or crossways.
- Sudden acceleration or deceleration in wet or icy conditions may cause sliding and ultimately loss of control.
- When there are potholes, dips, or bumps in the road, slow down well in advance to reduce jolting and bobbing of the tow vehicle and RV.
- When driving on uneven surfaces, reduce towing speeds. Before accelerating once more, ensure you are through the uneven section and well onto level surfaces.

4. Turning Corners

When turning, the RV will make a tighter turn than your tow vehicle and not follow in the same path as your tow vehicle. To ensure you compensate for this difference, take wider turns with the RV. In intersections, you must carefully pull into the intersection further, so the RV has proper clearance for the turn.

WARNING

While turning, it is critical that you are completely aware of your surroundings and ensure proper clearances. Use caution when making turns to ensure that you avoid collisions with objects around you. When parking in tight locations, utilize a spotter as a guide. Use caution when taking sharp turns and corners and be aware that swerving while towing your RV can result in a loss of control, particularly at higher rates of speed.

5. Passing

When towing an RV, the tow vehicle is under greater load and will take longer to accelerate and reach highway speeds. Allow additional time when pulling out onto a road or while overtaking another vehicle.

When changing lanes, always accommodate for the extra length of your RV. Be cautious of your surroundings and be prepared to change the speed of your tow vehicle and your lane quickly and safely.

6. Backing Up

When selecting a campsite, choose a level site that you can pull through or back into. Prior to parking your RV, inspect the campsite to ensure it satisfies your expectations and that there are no unforeseen cautions.

- Ensure there is plenty of clearance for the RV.
- Make sure the path is free of ground level and/or hanging obstacles (i.e., large rocks, low dips, low-hanging limbs, electrical lines, etc.).
- It is best to choose a campsite that is on the driver's side.
 - Driver's side campsites allow the driver to better see the rear of the RV while parking.
 - Passenger side campsites hinder parking skills due to it being on the driver's "blind side."
- Properly position the tow vehicle and RV for backing into the site location.
- Make sure there are no obstructed views before beginning to park your RV.
- When reversing, do so slowly. Use the tow vehicle mirrors and back-up camera (If Equipped or Customer Supplied) to carefully guide you

into the desired parking location.

- Use your passenger as an additional guide to assist you. This will eliminate any hidden "blind spots."

7. Parking

Once the RV is in the desired position:

- Place the tow vehicle into park and engage any other possible parking brake.
- Turn the ignition of the tow vehicle **OFF** and remove keys.
- Block the rear wheels of the RV securely with wheel chocks (Customer Supplied).

+ NOTICE

Wheel chocks are an important item to maintain in your RV or tow vehicle. Wheel chocks are not supplied with your RV. It is important that you either purchase wheel chocks in the aftermarket or utilize appropriately sized wood blocks that prevent the RV from rolling.

H. UNHITCHING FROM THE TOW VEHICLE

After the RV is properly parked and the wheels are blocked from rolling, it is time to unhitch your RV.

UNHITCHING YOUR RV FROM THE TOW VEHICLE:

1. **STABILIZE** the RV by lowering the front landing gear legs (front jack on Travel Trailer). For proper operation, refer to the manufacturer's instructions.

SEC.06 TOWING & LEVELING

2. **DISCONNECT** the 7-way wire harness/connector plug connecting the RV and tow vehicle.
3. **UNCLIP** the breakaway cable for the safety switch from the tow vehicle.
4. **OPEN** the vehicle tailgate unless it is designed specifically for dove tail hitch connections.
5. **(FW ONLY)** Shift the tow vehicle into reverse, but **DO NOT** press the accelerator. This removes pressure off the locking bar, to allow it to properly disengage
6. **(FW ONLY)** Once the pressure is alleviated from the locking bar, apply the brakes and place the tow vehicle back into park.
7. Disengage the locking bar and disconnect the pin box of the RV from the hitch of the tow vehicle (**TT ONLY** - lift the release handle on the coupler Travel Trailer. Disconnect safety chains and use the front jack to lift the coupler off the ball hitch).
8. After the pin box is fully released, slowly pull the tow vehicle forward. **DO NOT** pull away at an angle. Doing so may result in damage to the tow vehicle or RV.
9. Level the RV starting from front to back. For proper operation, refer to the leveling manufacturer's instructions. See [Section 6J](#).

⚠ WARNING

DO NOT USE THE LANDING GEAR LEGS (FRONT JACKS) OF THE FIFTH WHEEL OR FRONT JACK OF THE TRAVEL TRAILER TO SUPPORT THE WEIGHT OF THE TOW VEHICLE.

⚠ WARNING

FULLY RETRACT THE LANDING LEGS OR FRONT JACK PRIOR TO MOVING THE RV IN ANY WAY TO PREVENT DAMAGE!

+ NOTICE

When parking on gravel, dirt, or asphalt on a hot day place a block of wood or pad under each landing leg to prevent them from sinking into the surface. Make sure the same material is used under each leg to ensure the load remains evenly distributed.

I. Welded Rear Hitch (If Equipped)

Your unit may be supplied with a rear towing hitch. This hitch type can be used as an accessory hitch for cargo.

- Maximum tongue load capacity is 300 lbs. (136 kg).
- The receiver size is 2".
- **DO NOT** exceed the Hitch Weight Ratings for your welded rear hitch.
- **DO NOT** use the hitch receiver to tow.
- Failure to do so may void the warranty.

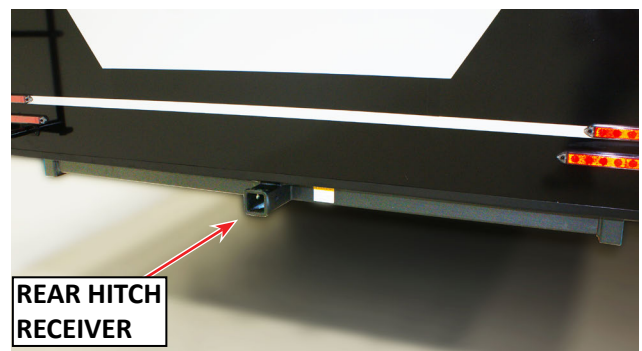

⚠ DANGER

Maximum load capacity of the rear hitch is **300 lbs. (136 kg)**. This weight includes the cargo, the storage container, straps, and all other related items. **DO NOT** exceed this limit. Doing so may result in failure of the hitch leading to property damage, injury, or even death.

⚠ DANGER

The hitch receiver on your Model I Travel Trailer is **NOT** designed for towing. **DO NOT** use the hitch receiver to tow anything behind your Model I. Doing so may result in failure of the hitch leading to property damage, injury, or even death.

J. LEVELING THE RV

1. General Information

The Model I is not equipped with an automatic leveling system onboard, and must be leveled manually. Leveling and stabilizing the RV is important for numerous reasons. It helps keep interior cabinet and appliance doors closed, allows slide outs and appliances to operate correctly, and improves the overall living comfort and safety while camping.

The process to level and stabilize your Model I is simple, starting with selecting a campsite that is as level as possible. If additional leveling is required, follow these steps to level and stabilize the RV:

1. Use a leveling tool (like a large carpenter's level, or an electronic level measuring device - not provided) to determine how much to raise one side, and to raise or lower the front to get the unit to level

2. Use the tow vehicle to pull the RV up on stackable RV leveling blocks to raise one side (bringing the unit into level side-to-side). Stackable leveling blocks provide a stable, locking platform for the tires. Follow the manufacturer's instructions for stacking and connecting the blocks.
3. Chock the tires into position on both sides of the RV to secure it in place.
4. Once secured into place, disconnect the trailer coupler from the tow vehicle hitch.
5. Use the tongue jack to raise or lower the front end of the RV to achieve level overall.
6. Prepare to deploy the stabilizer jacks to stabilize the trailer.

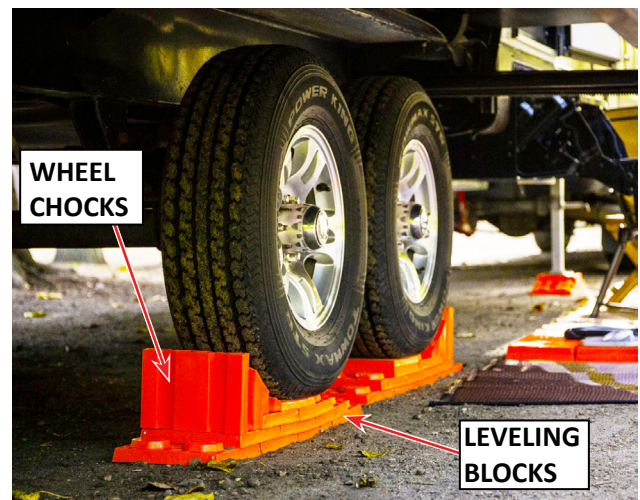

K. STABILIZER JACKS

⚠ WARNING

Failure to act in accordance with the following instructions may result in death, serious personal injury or severe product or property damage. **Always make sure the stabilizer area is clear of pets, people and objects before and during operation of the system. Always keep away from the stabilizer legs when in operation.**

SEC.06 TOWING & LEVELING

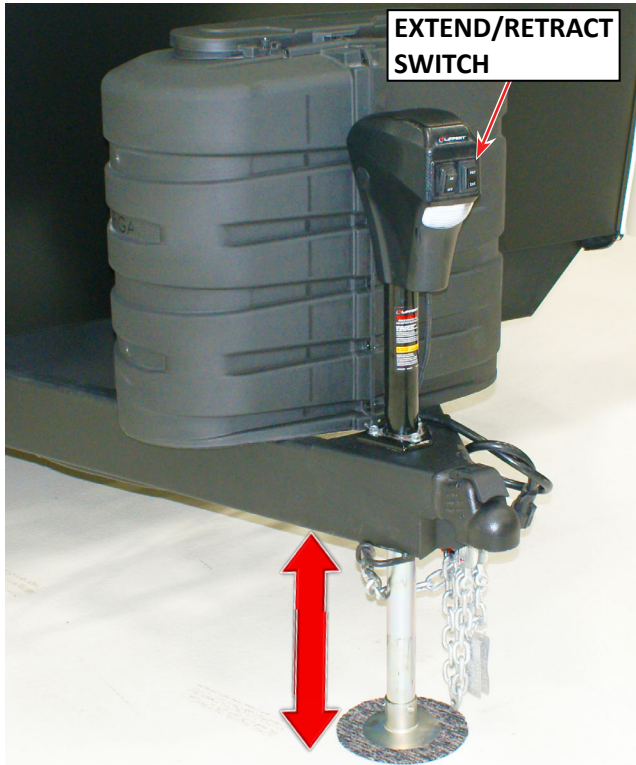

⚠ CAUTION

The PSX1 is to be used for stabilizing the trailer, not leveling the trailer. The stabilizer legs should never be extended longer than two seconds beyond initial contact with the ground.

⚠ CAUTION

Moving parts can pinch, crush or cut. Keep clear and use caution.

⚠ CAUTION

Never lift the trailer completely off the ground. Lifting the trailer completely off the ground creates an unstable condition that could result in property damage and personal injury.

The PSX1 is intended for the purpose of stabilizing the trailer after the trailer has been leveled.

1. Make sure the trailer is on solid, level ground.
2. Clear all stabilizer leg landing locations of debris and obstructions. Locations should also be free of depressions.
3. When parking the trailer on extremely soft surfaces, utilize load distribution pads under each stabilizer leg.
4. People and pets should be clear of trailer while operating the stabilizers.
5. Verify the battery is fully charged and hooked up to the electrical system.
6. Press and hold “EXTEND” on the switch (Fig. 1A) for the rear stabilizer until the footpads of the stabilizer legs contact the ground and the rear of the trailer is stabilized. Then release the switch.
7. If a front stabilizer is installed, press and hold “EXTEND” on the switch for the front stabilizer until the footpads of the stabilizer legs contact the ground and the front of the trailer is stabilized. Then release the switch.



⚠ CAUTION

Once the stabilizer legs have been extended, do not use the tongue jack on a travel trailer or the landing gear on a 5th Wheel. Damage to the stabilizer legs can occur when lifting or leveling the trailer after the stabilizer legs have been extended. Doing so will void the warranty of the stabilizers.

Retracting Stabilizers

1. Verify the battery is fully charged and connected to the electrical system.
2. If a front stabilizer is installed, press and hold “RETRACT” on the switch for the front stabilizer until the stabilizer legs are fully retracted.
3. Then release the switch.
4. Press and hold “RETRACT” on the switch for the rear stabilizer until the stabilizer legs are fully retracted. Then release the switch.

Stabilizing System

By keeping the “EXTEND” switch engaged for one to two seconds after the legs’ footpads make contact with the ground, the trailer will be stabilized and ready for use.

In the event the system shuts off while trying to stabilize the trailer, an in-line auto-reset circuit protection has tripped and will reset within 10 seconds. This is an indication the PSX1™ is not being used as intended and is trying to lift too much weight.

Note: Make sure the stabilizer legs are fully retracted before moving the trailer.

Manual Override

The PSX1 comes with a manual override system located on the stabilizer end opposite the electric motor.

To manually operate the stabilizer:

1. Disconnect one of the wire leads from the motor to prevent backfeeding the motor.
2. Next, insert the 1/2” diameter manual crank handle over the coupler and pin at the end of the stabilizer. The slot in the end of the crank handle accommodates the pin on the coupler to allow the manual extension/retraction of the stabilizer legs.

⚠ CAUTION

The gears can be stripped if the stabilizer legs are retracted/extended to the fullest extent and the operator continues to rotate the manual override. Do NOT use a power tool to extend or retract stabilizers.

3. Rotate the crank handle clockwise to extend or counterclockwise to retract the stabilizer legs.

K. System Maintenance**⚠ WARNING**

Do not work on the stabilizer unless the battery is disconnected. Failure to act in accordance with the following may result in death, serious personal injury or severe product or property damage.

SEC.07 SLIDE-OUT SYSTEMS

Mechanical Maintenance

It is recommended that when operating in harsh environments, e.g. road salt or ice buildup, the moving parts be kept clean. They can be washed with mild soap and water. The ACME screw is pre-coated with grease. If the screw is cleaned, it may be necessary to add grease to the screw to ensure smooth stabilizer operation.

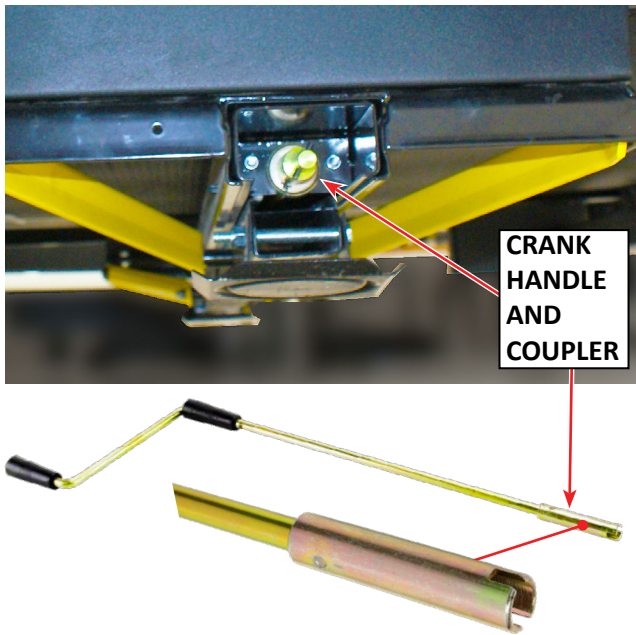

⚠ CAUTION

Operating the stabilizer without grease on the screw could lead to product failure.

Electrical Maintenance

For optimum performance, the system requires full battery current and voltage. The battery must be maintained at full capacity. Other than good battery maintenance, check the terminals and other connections at the battery, the control switch and the electric motors for corrosion and loose or damaged terminals. Check motor leads under the trailer chassis. Since these connections are subject to damage from road debris, make sure they are in good condition.

Scan the QR Code to view a sample video on manual RV leveling.

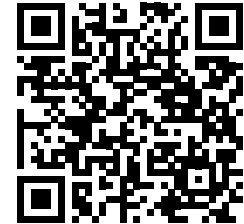

A. GENERAL INFORMATION

Slide-out rooms are designed to provide you additional living space during stationary camping.

- To extend, retract, and to seal a slide-out correctly, the RV must be level. If the RV is NOT level, the slide-out rooms and/or their pertaining parts may become damaged or leak.
- Slide-outs do not need additional support. Any damage that results from such support may not be covered under the warranty. This includes any damage that may result from the improper use or use of aftermarket support jacks.

⚠ WARNING

Before operating any slide-out, review and understand all operation instructions and safety alerts.

⚠ WARNING

Slide-outs and slide-out mechanisms are crush hazards. Fully disable the auxiliary battery and turn OFF the breaker for the converter on the distribution panel BEFORE working on or under a slide-out. Failure to do so may result in serious injury or death.

⚠ WARNING

Before extending or retracting a slide-out, make sure the surroundings are clear of objects, people, and pets. Failure to do so could result in serious injury or death.

+ NOTICE

Prior to operating a slide-out, ensure sufficient power is available and that the RV is properly leveled. Failure to do so may result in damage to your slide-out or slide-out mechanism.

B. OPERATION

It is normal for slide-outs to make noises such as squeaking or creaking while being operated. These noises are more common during the “break in period” of the RV and will continue until components and materials are seated properly. After a few uses, this noise will likely reduce.

SLIDE-OUT OPERATION:

1. **BEFORE** operating any slide, level and stabilize the RV.
2. Ensure wheels are properly chocked.
3. Ensure there is a proper energy source. If power is supplied by the campground, make sure you are properly connected. If you are running the slides with auxiliary power, make sure the battery is fully charged and all unnecessary lights and power consumption is limited to maximize available power for slide-out operation.
4. **PRIOR TO** extending or retracting the slide:
 - a. Close all cabinet doors and drawers.
 - b. Ensure the interior path for the slide-out is clear of people, pets, furniture, and/or any other possible object that may obstruct the slide-outs path.
 - c. Ensure the exterior path for the slide is free of trees, electric lines, or any other possible obstructions.

SEC.07 SLIDE-OUT SYSTEMS

5. To extend, press and hold the **OUT** or **EXTEND** button on the Brinkley Command Center. **DO NOT** release until the room is completely extended or retracted (unless an obstruction is in the slide-out's path). A slight delay may occur before the slide-out begins to move. This is normal.
6. **BEFORE** retracting, inspect the exterior walls, roof, and floor of the slide-out. If any of the surfaces are wet, be sure to dry them before retracting.
7. If water puddles or debris are present from the use of a slide, clean and dry the area immediately.
8. To retract, press and hold the **IN** or **Retract** button on the Brinkley Command Center. **DO NOT** release until the room is completely extended or retracted (unless an obstruction is in the slide-out's path).

+ NOTICE

There will always be some noise that accompanies the operation of extending and retracting the slide-out.

⚠ WARNING

The slide-out mechanism contains sharp edges. To prevent injury, **DO NOT** allow children to play under the slide-out under any circumstance. **BEFORE** working on or going under a slide-out, make sure **ALL** power to the slide is disconnected. Failure to do so may result in serious injury or death.

⚠ WARNING

Ensure all slide-outs are fully retracted **PRIOR TO** hitching the RV to the tow vehicle. Failure to do so may result in damage to your RV, serious death, or injury.

⚠ WARNING

Ensure the interior and exterior path for the slide-out is clear of people, pets, furniture, and/or any other possible object that may obstruct the slide-out's path. Failure to do so may result in damage to your RV, serious death, or injury.

+ NOTICE

For the slide-out to seal correctly, the room must be fully extended or retracted. Once the slide-out is fully extended or retracted, release the slide switch immediately. Running the switch beyond slide extension will result in damage to the slide-out motor.

C. SLIDE-OUT MAINTENANCE

While a slide-out is fully extended, the slide surfaces will be exposed to and will collect water, dirt, ice, and other miscellaneous debris. Slide-out seals are not designed to remove such debris. All slide-out exterior surfaces should be dry and clean prior to retracting the slide.

Prior to retracting slide-outs:

- Inspect the outside surfaces for snow, ice, dirt, water, insect nests, etc.
- Check for standing water, snow, or ice on slide-out awning toppers (If Equipped).
- Clean and dry all exterior surfaces of the slide-out and the slide-out mechanism as much as possible.

⚠ CAUTION

Before operating a slide-out, the RV must be leveled. Water leaks and other problems may result with the failure to do so.

⚠ WARNING

Do not place excessive weight within the slide-out. Over-loading a slide out may result in malfunction leading to damage to the slide mechanism, injury, or death.

+ NOTICE

For long-term storage, it is recommended that all slide-outs be stored with slide rooms fully retracted.

For troubleshooting and/or repair, please contact your Authorized Dealer or Brinkley RV Customer Care team. Examples of when to contact may include, but are not limited to, the following:

- Slide motor stalls before the slide reaches full extension or retraction.
- Slide does not properly close or seal correctly.
- Slide retracts or extends unevenly.
- Slide puts out unusual sound upon operation.



SLIDE SWITCHES ON THE COMMAND CENTER

D. LIPPERT THROUGH FRAME ELECTRIC SLIDE-OUT SYSTEM (IF EQUIPPED)

One type of slide mechanism utilized by Brinkley RV is the Lippert Through Frame Electric Slide-out System. This system's function is to allow the slide room to fully extend and retract at the push of a button. The through-frame system is a rack and pinion guided system using an electric ball screw actuator to move the room assembly. The actuator comes equipped with an automatic clutching system and is design to operate as a negative ground system. Please refer to the manufacturer's manual for complete instructions on use, maintenance, and limitations: <https://lci-support-doc.s3.amazonaws.com/manuals/slideouts/ccd-0001614.pdf>.

⚠ WARNING

Fully disable the auxiliary battery and turn OFF the breaker for the converter on the distribution panel BEFORE manually operating the system. Failure to do so may cause electricity to back feed from the motor and cause damage to the system and will void the warranty.

1. Manual Operation

The Lippert Through Frame Electric Slide-out System comes with a manual override feature. To manually override, the system, see the instructions below. Locate the 1" access hole for the slide-out override in the skirt metal on the opposing side of the slide you are attempting to override.

Manual Override:

- Disconnect your RV battery.
- Locate 3/4" crank handle supplied with the RV Located in the front pass-through compartment.
- Position crank handle extension.
- Turn clockwise to retract the slide-out.
- Turn counter-clockwise to extend the slide-out.

SEC.07 SLIDE-OUT SYSTEMS

IMPORTANT: The actuator is prepared for manual override.

- **DO NOT** disengage the motor at any time.
- Simply apply the crank to the override and begin to crank.

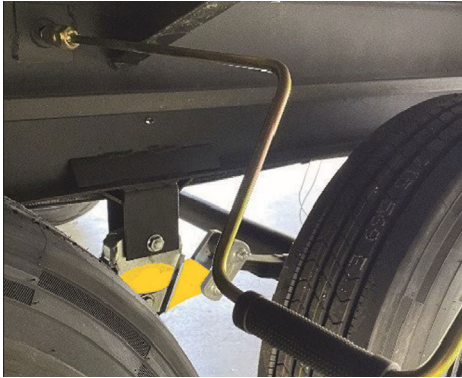

2. Maintenance

The slide-out mechanism is designed for minimal maintenance. Operate each slide-out once or twice a month to keep the seals and all other internal moving parts lubricated and flexible.

- The best operation of a slide-out system requires the auxiliary battery to be fully charged.
- Inspect for loose, corroded, or damaged components at the battery terminals, control switch, and slide motor.
- When operating the slide-out system in harsh environments (i.e., road salt, environmental salts, ice buildup, under trees, etc.) keep all moving parts clean and clear of debris.
 - Remove all ice buildup and other debris.
 - Dry all water that is collected.
 - Wash as needed with mild soap and water and then dry.
- Apply dry, non-silicone-based lubricants as needed.

For additional maintenance instructions, please refer to the [Lippert's Electric Through Frame Slide-Out System Service Manual](#).

3. Service and Adjustments

- Every 90 days, slide-out rooms should be inspected to ensure proper function of the slide and its related seals.
- Every 6 months, slide-out rooms should be adjusted and inspected by a certified RV service technician.
- Any adjustments made by non-certified person or entity may void the warranty.

E. LIPPERT IN-WALL SLIDE-OUT SYSTEM - SLIM-RACK (IF EQUIPPED)

1. General Information, Extending, and Retracting

Another slide system utilized by Brinkley RV is the Lippert SlimRack® system. Unlike a through frame that passes through the RV chassis, this system is mounted to the wall structure.

Note that it is normal for slide-outs to make noises such as squeaking or creaking while being operated. These noises are more common during the “break in period” of the RV and will continue until components and materials are seated properly. After a few uses, this noise will lessen.

The SlimRack system has two gear racks on either side of the slide room.

The controller for the SlimRack Slide-Out system is located in the bulkhead storage compartment. If you experience issues with your Slim Rack, Lippert's troubleshooting guide will require you to review this controller for error codes.

OPERATE THE SLIMRACK SLIDE-OUT SYSTEM:

- **BEFORE** operating any slide, level and stabilize the RV.
- Ensure wheels are properly chocked.
- Ensure there is a proper energy source. If power is supplied by the campground, make sure you are properly connected. If you are running the slides with auxiliary power, make sure the battery is fully charged and all unnecessary lights and uses are limited to maximize available power.

PRIOR TO extending or retracting the slide:

- a. Close all cabinet doors and drawers.
 - b. Ensure the interior path for the slide-out is clear of people, pets, furniture, and/or any other possible objects that may obstruct the slide-outs path.
 - c. Ensure the exterior path for the slide is free of trees, electric lines, or any other possible obstructions.
- To extend, press and hold the **OUT** or extend button on the Brinkley Command Center. **DO NOT** release until the room is completely extended or retracted (unless an obstruction is in the slide-out’s path). A slight delay may occur before the slide-out begins to move. This is normal.
 - **BEFORE** retracting, inspect the exterior walls, roof, and floor of the slide-out. If any of the surfaces are wet, be sure to dry them before retracting.
 - If water puddles or debris are present from the use of a slide, clean and dry the area immediately.

- To retract, press and hold the **IN** button on the Brinkley Command Center. **DO NOT** release until the room is completely extended or retracted (unless an obstruction is in the slide-out’s path).

2. Troubleshooting

For troubleshooting information, please refer to the [Lippert SlimRack Slide-Out Owner’s Manual](#).



A. GENERAL INFORMATION

Your Brinkley RV Fifth Wheel is equipped with a 120-volt 60hz AC power and a 12-volt DC power system. The electrical system and all its components are engineered and design specifically for RVs. All installations and components utilized meet or exceed the RV industry standards applicable as of the date the RV is manufactured.

- Hazardous conditions may occur as a result of aftermarket modifications or additions made to the RV pertaining to the RV electrical system.
- Modifying or making unauthorized additions within the RV is NOT recommended by Brinkley RV.
- ONLY your Authorized Dealer or a qualified electrical technician should perform service to the electrical system within the RV.

When providing maintenance or repairs to the RV, only components, methods, and materials that follow current safety and code requirements are permitted. Please consult with your Authorized Dealer's Service Center for assistance.

When providing maintenance or repairs to the RV, only components, methods, and materials that follow current safety and code requirements are permitted. Please consult with your Authorized Dealer's Service Center for assistance.

WARNING

Use caution when working on the electrical system, especially when using metal tools. When a metal tool encounters a live, powered source it will cause the system to short circuit resulting in personal injury, property damage, explosion, or fire.

B. ELECTRICAL SYSTEM MAINTENANCE

- **BEFORE** working on or near an electrical system, **ALWAYS** disconnect the negative 12-volt terminal on the battery and the shore power cord.
- **PRIOR TO** disconnecting the battery, **ALWAYS** make sure the power to the converter is turned off. Failure to do so, may result in damage to your RV or personal injury.

For more information on the electrical system within the RV, please refer to the component manuals in the Owner Information Package.

WARNING

The power cord **MUST** be fully extended and not coiled on the ground or in the compartment when in use. When the power cord is left in a coil, it may generate enough heat to melt the protective casing resulting in damage to the RV, personal injury, or fire.

C. 50-AMP POWER CORD

The power cord commonly referred to as the shore or shore power cord connects the RV to an external power receptacle commonly found at campsites (see picture below). The purpose of this power is to:



SEC.08 ELECTRICAL SYSTEMS

- Supply an electrical feed from the external power receptacle to the RV.
- Supply proper ground to the electrical system within the RV from the external power source.

+ NOTICE

PRIOR TO connecting the RV to ANY external power source, ALWAYS test the external power with a Line Monitor or Clarity Tester (Customer Supplied). If the receptacle or source indicates Reverse Polarity or an open ground, DO NOT connect the RV.

1. CONNECTING POWER:

1. Disconnect power to the load center by flipping the main 120-volt circuit breaker.
2. Remove the shore cord from the RV and fully stretch the cord so it is not coiled.
3. Plug the shore cord into the external power source provided. Ensure that all prongs on the shore cord are fully seated within the external receptacle.
4. Returning to the RV, flip the load center breaker back to the ON position.
5. Follow the below instructions to help prevent damage from occurring due to power surges:
 - a. Disconnect the shore power cord any time the RV is left unattended. This will lessen the damage if a power surge were to occur while you are away from the RV.
 - b. Prevent damage from occurring to the prongs of the shore cord when connecting and disconnecting from external power sources.
 - c. When departing or needing to disconnect the power source, follow these steps:

- i. Disconnect the load center power.
- ii. Unplug the shore cord from the external power source.
- iii. Recoil the shore cord and stow it away.

+ NOTICE

NEVER disconnect the power cord, or shore cord, at the RV. Always disconnect the power cord, or shore cord at the external receptacle. Also, never remove the power cord by pulling on the cable. Always disconnect by pulling on the end connector that plugs into the outlet.

2. Power Cord Maintenance

Frequently inspect the components of the power cord for cracks, cuts, worn/melted insulation, and exposed wires. If any of these conditions are present, discontinue use and replace immediately.

⚠ WARNING

Circuit breakers and fuses are meant to function as a safety measure that will disconnect power once the system becomes overloaded or compromised but will not offer complete protection from events such as voltage spikes or varying surges.

⚠ WARNING

Any breaker that is replaced must be replaced with that of the same amperage ratings and type as the one removed. NEVER use a higher rated replacement circuit breaker. Failure to follow this instruction may result in overloading the wiring system ultimately leading to overheating, damage to the RV, and/or fire.

⚠ WARNING

For 50-amp systems only: Ensure that the external power source is a 50-amp NEMA 14-50 RV receptacle and NOT a 240-volt AC receptacle.

D. 120-VOLT AC SYSTEM

1. General Information

Your Brinkley RV fifth wheel is equipped with a 50-amp electrical service. This service is designed to operate on two (2) 120-volt power legs at a maximum flow of 50-amps/leg. When connecting to an external power source, the source must be a 50-amp service. When connecting to electrical service at a campground, the electrical service may occasionally experience spikes or drops in voltage.

+ NOTICE

Voltage spikes and drops can damage and/or shorten the service life of the electrical system and all the components it supplies power to.

The below electrical components will ONLY operate when the RV is connected to shore power:

- Air conditioner.
- Converter.
- Microwave.
- Receptacles.
- TVs.
- Fireplace.
- Hot water heater.

For recommendations on power-surge protection and protectors, please contact your Dealer.

2. 120-Volt Circuit Breakers

All 120-volt AC circuit breakers are located within the load center that can be found in the bottom of the bedroom dresser. These breakers function to protect 120-volt wiring and their supplied components. Each breaker found within the load center will be identified and labeled.



- If an overload or short circuit occurs, the exposed breaker will trip causing the electrical flow to stop beyond the breaker itself.
- Once the breaker trips, allow time for the breaker to cool.
- To **RESET** the tripped circuit breaker, flip the breaker switch to the **OFF** position and then flip it back to the **ON** position.
- Contact your Authorized Dealer to diagnose and repair the electrical system if a given breaker immediately trips once it is reset or if it frequently trips in a short amount of time.

Maintenance and Replacement

Circuit breakers can wear out over time due to

SEC.08 ELECTRICAL SYSTEMS

extensive use or exposure. Breakers should be inspected on an annual basis prior to the start of camping season. Replace breakers as needed but be sure they are replaced with the same rating and type that were originally installed.

⚠ WARNING

To confirm the circuit breakers are operational, flip the breaker to the OFF position and then back to the ON position. As soon as you recognize unusual operation, discontinue use, and contact your Dealer for further testing and assistance. Failure to do so may result in damage to the RV, personal injury, or fire.

3. Converter

The Power Converter within the RV converts 120-volt AC power to usable 12-volt DC power once the RV is connected to an external shore power source. This converter is in the base of the bedroom dresser and contains two 35-amp fuses to protect the converter from overheating. If overheating occurs, it is generally due to operating too many 12-volt systems at the same time for an extended period with little to no airflow. To help prevent overheating from occurring:

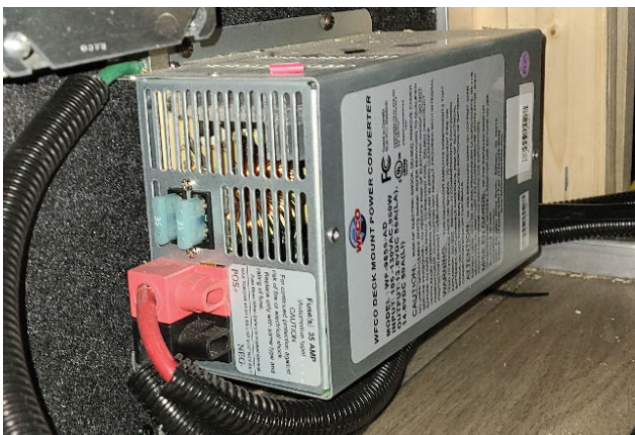

- Do not utilize unnecessary 12-volt systems (i.e., lights, motors, appliances, etc.).
- Keep the cooling fan clear

of any obstructions.

- Allow for proper ventilation in high temperature weather conditions.

Inspection and Maintenance

If the converter is not functioning or if the auxiliary battery is not charging when connected to shore power, it should be inspected.

CONVERTER INSPECTION WHEN BATTERY DOES NOT CHARGE:

1. Locate the converter (located in a front compartment behind an access panel).
2. Locate the two (2) 35-amp fuses on the converter.
3. Inspect and replace the fuses as needed.

For further assistance, please contact your Dealer.

+ NOTICE

Do not remove the converter from the RV or tamper with the housing. Doing so will void warranty. There are no serviceable parts within the converter that should ever be tampered with.

4. GFCI Receptacle

Ground wires help to stabilize current and offer a secondary path for electrical currents to travel in the case of exposure to a high voltage spike. This in return helps to prevent an electrical shock.



Every Brinkley RV contains ground fault current interrupters (GFCI) designed specifically for the electrical system within your RV. GFCI's are designed to monitor the flow of electrical current between hot and neutral conductors and sense if an abnormality occurs. This circuit and device are designed with the intent to reduce possible injury caused by an electrical shock

+ NOTICE

A GFCI will not protect against circuit overloads or short circuits.

When a GFCI receptacle senses an abnormally high 120-volt current present through the grounding circuit, the GFCI will trip. This occurrence will generally happen when wires become wet inside an appliance, faulty wire insulation, a short within electrical equipment, etc.

FREQUENTLY TEST GFCI RECEPTACLES.

TESTING A GFCI:

1. Push the TEST button on the receptacle. This should immediately pop the reset button which indicates the GFCI has been "tripped". Once tripped, no 120-volt power will flow through the receptacle.
2. Verify no power is present. This should be performed with a receptacle tester (Customer Supplied).
3. Once you are sure no power is present, press the **RESET** button. This should restore the flow of 120-volt power.
4. Verify the presence of power with the same receptacle tester.
5. If the GFCI does not test properly or is defective, please contact your Dealer for assistance.

E. 12-VOLT DC SYSTEM

Many RV components including the water pump, lights, motors, appliances, etc. operate on 12-volt electricity.

- The Power Converter will convert the power to 12-volt power when the RV is connected to external shore power. The converter will also charge the auxiliary battery in the RV.
- The Auxiliary Battery supplies 12-volt power to the RV when no external power is supplied but should not be used as the main electrical source.
- When towing, the alternator of the tow vehicle will supply 12-volt power if the 7-way wire harness is properly connected, and the tow vehicle engine is operating.

The 12-volt power runs many of the key components needed for travel including brake lights, turn signals, running lights, and the breakaway switch. In addition to supplying power to these essential components, the 7-way wire harness will also provide a power source to charge the auxiliary battery within the RV.

1. 12-Volt DC USB Ports

Within your RV you will find several 12-volt DC USB ports (i.e., in living room end tables, the sofa center console, some receptacles, etc.). When using these outlets, only use them on appliances and components that only require 12-volt and consumes less than 60 watts, or 5-amps. To prevent short circuits from occurring, keep all 12-volt USB ports free of any debris or foreign material.

2. 12-Volt Fuse Panel

- Within the 12-volt fuse panels, labels will indicate the fuse locations, sizes, and component it powers. Never remove any of these labels.
- Inspect all fuses on a continuous basis, especially prior to camping season and replace as needed.

SEC.08 ELECTRICAL SYSTEMS

+ NOTICE

In the event of a power spike or surge, fuses may not offer complete protection for you or the RV.

REPLACING FUSES:

ALWAYS turn off or unplug components PRIOR TO replacing a fuse. This will help to protect the components within the RV.

1. Before beginning, disconnect the shore power cord from the external power source.
2. Disconnect the negative terminal from the auxiliary battery within the RV.
3. Access the fuse panel and inspect fuses.
4. Remove the fuse by pulling straight back on the fuse from the fuse block.
5. Replace as needed.

Please contact your Dealer if the fuse is not blown and you are still experiencing electrical issues or if a circuit keeps blowing a fuse.

⚠ WARNING

Never replace a fuse with one that contains a different amperage rating or another type other than the original. Failure to do so may result in personal injury, damage to the RV, or fire.

3. Auxiliary Battery

The RV contains multiple 12-volt circuits. When all circuits are combined, the voltage load is much greater than what the converter can produce. In such high demand situations, it is recommended for an auxiliary battery to be installed (Customer Supplied). The use of an auxiliary battery will allow the system to sustain much longer in high

demand situations. A Group 27 deep cycle battery or LiFePO4 Lithium-Ion battery should be the battery installed within your RV.

4. Dry Camping

Dry camping, also known as boondocking, involves camping in your RV with no electric or water hookups. Prior to dry camping with your RV, make sure the auxiliary battery is fully charged. If the components within the RV are strictly running off the power supplied by the auxiliary battery, and the battery is not being charged, the battery will sustain power momentarily but will quickly become depleted with use. As an auxiliary battery becomes depleted and the charge lessens, it will discharge at a faster pace. It is highly recommended that you plan your electrical usage accordingly.

To ensure your battery is fully charged, test the auxiliary battery voltage using a volt-ohm meter. When an auxiliary battery is fully charged, it will read 12.4- to 12.8-volts and 1.265 specific gravity at 80°F (32°C). The auxiliary battery is deemed discharged at 11.8 volts and dead once it hits 11.65 volts or below. When voltage drops below 11.65 volts, the battery is at risk of permanent damage.

Under normal conditions, a deep cycle battery has an amp-hour rating of 75-100 amps. To determine the duration (in hours) of your battery power, take the battery amp-hour rating divided by the number of amps you are using. In [Section 8G](#), you will find the Amperage Chart for your RV that lists the normal amperages of the various components.

For example, if you are running the dinette lights (1 amps), the microwave (12 amps), and the water heater (12 amps) simultaneously, your battery power would only last 75-amp hours/(1+12+12 amps) = 3 hours.

**TOTAL BATTERY DURATION IN HOURS =
(Battery Amp-Hour Rating)/(Components Ran)**

In some cases, it is possible for the RV to drain the battery of the tow vehicle when the tow vehicle is not running, but is still connected through the 7-way plug to the RV. To prevent this from occurring, disconnect the 7-way plug when the tow vehicle is parked, and the engine is not running. Another way to prevent this from occurring is to install a Battery Isolator (Customer Supplied) on the tow vehicle. The Battery Isolator will act as a charging mechanism that will allow the tow vehicle to charge the battery within the tow vehicle itself as well as the RV battery while the tow vehicle engine is running.

+ NOTICE

It is very important NOT to discharge your tow vehicle battery below the level required to start the engine.

5. Maintenance/Replacement of 12V Equipment

Several components within the RV continuously draw battery power, even when the components are turned off (i.e., radio, TV, microwave, power tongue jacks, safety related equipment, etc.). The on-board memory of these components requires continuous power to save the memory. To prevent the auxiliary battery from being drained while not connected to shore power, utilize the master battery disconnect to fully disengage the battery. While the unit is in storage, it is best to fully remove the battery and place it on a battery maintainer. If you are unable to do so, it is suggested to check the voltage on the battery monthly and recharge as needed.

When purchasing a new battery or replacing an old battery, a Group 27 deep cycle battery or LiFePO4 Lithium-Ion battery should be purchased. For additional information or maintenance instructions, please contact the battery manufacturer for further assistance.

+ NOTICE

NEVER reverse the positive and negative terminals on the battery cables. Doing so will cause reverse polarity and blow the fuse protecting the converter.

F. BATTERY DISCONNECT SWITCHES

You will find three (3) battery disconnects within the RV: **the travel battery disconnect, solar power disconnect, and the master battery disconnect.** The travel battery disconnect will prevent components from drawing power from the battery but will still allow any memory-based appliances to maintain memory, operation of the refrigerator, safety components (such as the CO monitor), solar charging and the front jacks to maintain enough battery draw to function. The travel battery disconnect is located in the pass-through storage compartment on the door side of the RV.



SEC.08 ELECTRICAL SYSTEMS

The master, or main, battery disconnect will prevent all draw coming from any component within the RV including those that are memory-based, or safety related. It kills power to everything. The master battery disconnect is in the front bulkhead (or firewall) storage area.

When auxiliary power is not needed in the short term, the travel battery disconnect should be utilized.

- **TURN** the Battery Disconnect Switch from the **ON** position to the **OFF** position.
- The items listed above will remain operational.

The photos on the previous page show the location of the travel battery disconnect as well as a close up of the switch itself.

When the RV will not be in use over an extended period of time or is placed in storage, the master, or main, battery disconnect should be utilized.



- **TURN** the Battery Disconnect Switch from the **ON** position to the **OFF** position.
- **ALL** power will be disconnected, and **NO** power will be supplied to any component including any 12-volt safety or memory-based items.

The picture to the left shows the location of this battery disconnect in the front bulkhead storage.

G. CALCULATING ELECTRICAL LOAD

1. General Information

When connected to external shore power, the 120-volt AC system is capable of running a maximum of 100 amps momentarily and 50 amps on a continued basis. If this rating is exceeded, the RV and/or electrical system of the campground may become overloaded, and as a result the main breaker will trip.

+ NOTICE

DO NOT exceed the combined amount of 100 amps at any given time. To calculate the amps used, the draw of all components being utilized must be added together. To calculate an amperage rating for an appliance, take the wattage of the appliance divided by the voltage. Both the wattage and voltage should be listed on the appliance. For example: A 1200-watt appliance rated at 120 volts would utilize: $1200 \text{ watts} / 120 \text{ volts} = 10 \text{ amps}$.

120 VOLT SYSTEM		12 VOLT SYSTEM		12 VOLT SYSTEM	
AIR CONDITIONER	14-18 AMPS	AISLE LIGHTS	0.5 AMPS	LP DETECTOR	0.125 AMPS
COFFEE MAKER	6-12 AMPS	BAGGAGE COMPARTMENT LIGHTS	0.5 AMPS	PORCH LIGHT	1.5 AMPS
CONVERTER (EACH)	8-11 AMPS	DECORATIVE WALL LIGHTS	0.5 AMPS	POWER AWNING	10 AMPS
CURLING IRON OR HAIR DRYER	10-14 AMPS	DINETTE LIGHT	0.5-1 AMPS	POWER VENT	5 AMPS
MICROWAVE	12 AMPS	FANTASTIC (VENTILATION) FAN	1.5 AMPS	REFRIGERATOR	5.3 AMPS
SATELLITE RECEIVER	2 AMPS	3" LED PUCK LIGHTS (EACH)	0.22 AMPS	SHOWER LIGHT	0.22 AMPS
TV	2-4 AMPS	FURNACE	8-10 AMPS	TV PLATE/ ANTENNA BOOSTER	1 AMP
VACUUM CLEANER	8 AMPS	GENERATOR START	95 AMPS*	VANITY LIGHT	0.22 AMPS
WASHER/DRYER	12 AMPS	ILLUMINATED SWITCH	0.125 AMPS	WATER HEATER	6 AMPS
WATER HEATER	12 AMPS	LEVELING SYSTEM	95 AMPS*	WATER PUMP	7 AMPS

*Momentary Load

2. Approximate Electrical Load Ratings

Please see the above amperage chart to obtain the amps used with each component.

H. REPLACING LIGHT BULBS

Prior to replacing a light bulb, always make sure the light switch is turned off. This will prevent the flow of power to the light itself. Always make sure the light bulb is the appropriate size and type. If an incorrect bulb size is used, the electrical circuit can become overloaded causing the fixture to overheat and could cause a fire. Light bulb replacement is deemed Customer maintenance and must be provided by the Customer. Light bulbs are not covered by any warranty.

I. SOLAR POWER

A solar power system effectively charges the battery by converting solar energy to usable 12-volt power. As the battery becomes fully charged, the solar system will protect the battery from overcharging by limiting the feed of solar power supplied. In your RV, the solar system provides power to just 12 volt applications, but not to the appliances.

3. MPPT Charge Controller

Your unit is also equipped with a 30-amp Go Power (MPPT) Solar Charge Controller. The Solar Charge Controller (shown below) checks the voltage output of the solar panel(s), compares it to the battery voltage, and converts the voltage from the solar panel(s) to obtain the maximum current into the battery to ensure the quickest and most efficient charging of the battery or batteries. The Charge Controller is located in the front pass-through storage compartment.



SEC.08 ELECTRICAL SYSTEMS

Your Brinkley RV is equipped with a 200W solar panel and is prepped to add up to two additional 200W solar panels. The roof is supplied with additional backer to permit installation of the second panel. Please consult your Dealer or contact Brinkley Customer Care for the backer locations. Shown below is a picture of the standard 200W solar panel equipped on the roof of your Brinkley RV (location may vary by floorplan).

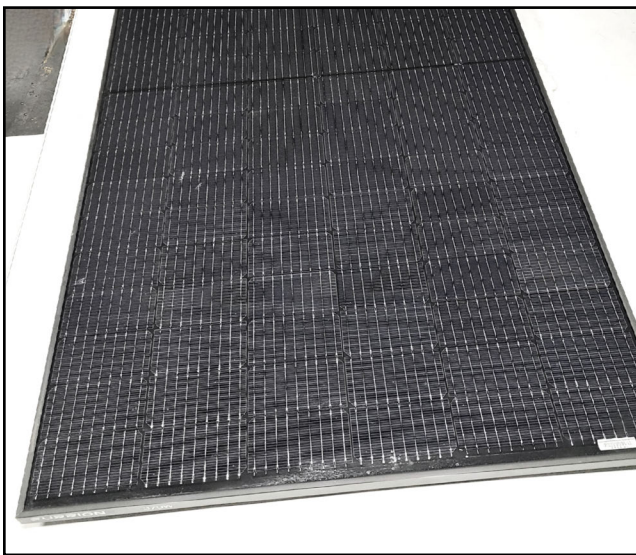

1. Solar Docking Port

The solar docking port inlet mounts directly on the roof of the RV and accepts the plug from the solar panel battery charger which enables you to charge your RV's 12V battery safely and quickly. The picture below left is a close-up view of the Solar Docking Port. The below right photo highlights the location of the Solar Docking Port relative to the solar panel.

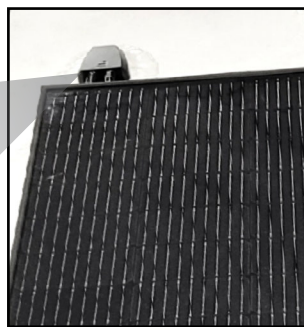

2. Solar Power Charging System

Prior to utilizing or installing a second solar panel, please read and understand the instructions and warnings within the manufacturer's manual for the 30 Amp MPPT Solar Charge Controller and Solar Panel. This information can be found in your Owner's Information Package.



+ NOTICE

All safety alerts, warnings, and instructions should be followed when installing and/or using any Solar Power.

3. Inverter

Your Brinkley Model I RV is equipped with a 3,000-watt inverter. It is located in the front cargo compartment, with the Inverter Remote Panel located in the same compartment below the Battery Disconnect Switches.

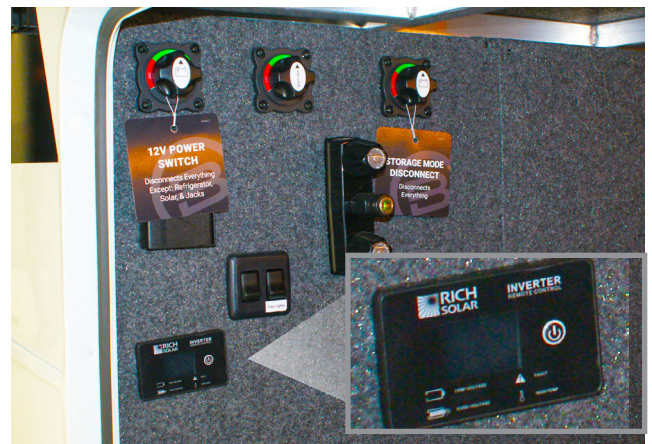

The inverter will generate considerable heat when in use. It is critical to keep the area around the inverter clear to allow for proper air circulation, particularly around the base where the ventilation fans are located.



It is also important to note that you have to power the inverter on when you wish to utilize it, and power it off when you do not require it to supply power. There are two ways to power on and off the inverter:

- a. From the power switch on the inverter itself; or
- b. From the provided inverter remote.

It is important to note that your 3000W inverter will only supply the unit with limited 120VAC power and will only operate specific items, such as 120VAC outlets, 120VAC GFI outlets, the microwave, and the living room smart window used for projector TV viewing.



The inverter provides power to circuits in the “subpanel” section of the 120VAC distribution panel (outlined in red).

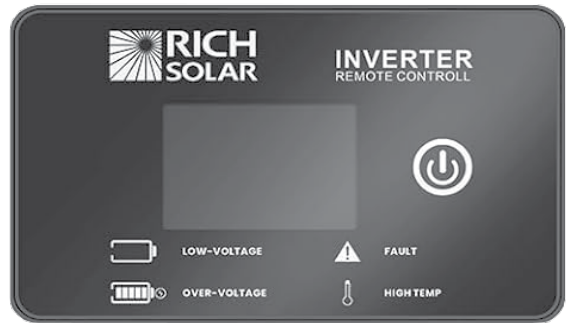

SEC.09 ELECTRONICS: AUDIO, VIDEO & THE RV CONTROL SYSTEM

A. INTRODUCTION

Within this section you will find information pertaining to the original audio and video components installed in your RV at the Brinkley RV factory. For additional information, please refer to the manufacturer's manuals found in Owner Information Package or visit their website. In the circumstance where an aftermarket modification or installation has been performed on your RV, please contact the servicing Dealer who performed the aftermarket modification or installation work for additional information.

B. AUDIO/VISUAL SYSTEM GUIDE

1. Interior Speaker

Your RV is equipped with speakers located under the dining room table in the main living area (shown below). They are Bluetooth speakers permitting you to pair it to your phone, tablet, TV or other Bluetooth enabled device.



The speakers have a controller that is located in the overhead cabinet by the entry door. The cabinet also contains the monitor panel and Maxx Air vent controller. This location may vary from floorplan to floorplan.



2. Exterior Speaker

Your RV is equipped with exterior speakers attached to the RV frame (one is shown in the picture below). The exterior speakers are controlled by a Bluetooth Controller located in the door side pass through storage compartment.

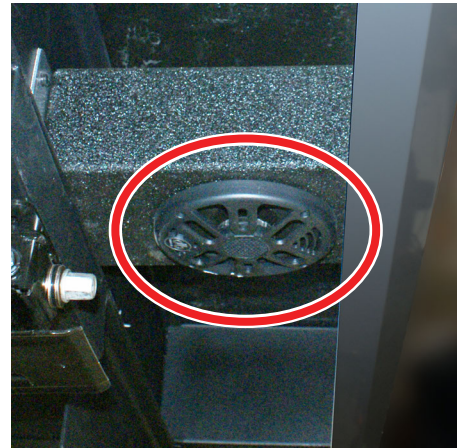

3. Important Items to Understand about your Speakers Systems

There are several important points to understand to avoid frustration when utilizing your interior and exterior speaker systems:

- a. After you initially pair to the speaker, when the controller for that speaker is turned on and in range of the paired device, it will automatically connect to that device if it is not already paired with another device.
- b. An audio device (cell phone, tablet, TV, etc.) can only be connected to one speaker (either the interior or exterior) at a time. You cannot pair to both to play the same audio on the interior and exterior of the RV simultaneously.
- c. Once you have successfully paired to one of the DBT100v2 Bluetooth Controllers, you should go to the Bluetooth settings on your connected device and rename the DBT100v2 Bluetooth Controller. This will prevent confusion between the interior and exterior controller when you are trying to pair in the future. It will also prevent confusion if you are trying to pair while parked in proximity to another Model I.

SUGGESTIONS FOR RENAMING

Interior Speaker = Z[use last 3 of VIN] Interior
Exterior Speaker = Z[use last 3 of VIN] Exterior

1. There must be audio present from the TV in order for the speaker to play the audio.
2. If you have already paired a device to the speaker via, Bluetooth, you will have to disconnect from the Bluetooth first before the TV audio will play.
3. If you would like to also utilize the TV speakers either in addition to the main living area speaker or only use the TV speakers, consult your TV manual for directions on how to accomplish your desired audio settings.

4. Pairing to the Bluetooth Speaker Systems

In order to pair your device (cell phone, tablet, TV, etc.) to one of the DBT100v2 modules, please follow the steps below:

BLUETOOTH PAIRING INSTRUCTIONS:

- 1. Turn on the DBT100v2 by pressing the power button. The POWER BUTTON should illuminate white in color and the MODE button will indicate it is in pairing mode by blinking blue in color.**
- 2. Access your bluetooth settings on the device you want to pair. In the list of available devices, find and select the one called "DBT100v2".**
- 3. Once the Bluetooth audio device is paired with the DBT100v2, the MODE button will stop blink and remain illuminated blue in color. This indicates that pairing was successful.**

SEC.09 ELECTRONICS: AUDIO, VIDEO & THE RV CONTROL SYSTEM

5. DBT100v2 Bluetooth Controller Button Functions

The DBT100v2 Controller has a series of buttons on its face that provide different functions. Your Bluetooth device itself (phone, tablet, TV, etc.) can still be utilized to change volume, switch tracks on your audio player, play and pause music, etc. There are also limited controls on the Bluetooth controller itself.

Below you will find a picture of the controller and a table that explains what the various buttons perform:



Button Functions	
	Play Next Track (only in BT Mode)
	Play Previous Track (only in BT Mode)
	Select Between Aux Mode (Red), BT Mode (Blue), BT Pairing Mode (Blinking Blue)
	Power On or Off Device / Play or Pause Track
	Volume Up
	Volume Down

NOTES

6. TV Operation—Main Living Area (IF EQUIPPED)

1. Raise the TV using the TV Lift switch.
The picture below shows the location of the switch in the main living area in the Model I 3100.
2. Turn on the power to the TV.
3. Select the signal input using the “source” selection on the remote.
4. Adjust the TV Antenna/Channel Tuning until service is found. See the TV Roof Antenna manual and TV manual for further instructions.



+ NOTICE

The TV within the RV is a smart TV. Various streaming platforms are available when connected to WiFi or cellular data.

⚠ CAUTION

When connecting or disconnecting the antenna and power supply cables to the TV, make sure the power is turned off. When testing for voltage, turn the TV on.

7. TV Reception Basics

TV signal transmission is a point-to-point communication system. Any obstructions between the transmitter and the antenna will weaken the signal and ultimately affect the picture quality. Local TV stations transmit their broadcast signal “over the air.” Antennas are designed to receive the local broadcast signal and display the image on the TV screen. Picture and sound quality depend on the type of antenna, the distance from the transmission, and the surrounding environment of the RV. The signal will weaken the further your antenna is from the source and the more obstructions in the path of the signal.

8. TV Signal Booster

To improve antenna reception, the TV Signal Booster must be turned ON.

- The TV Signal Booster works by amplifying all signals to improve the quality of the signal received by the TV.
- To turn the TV Signal Booster on or off, you must locate the antennae connection plate located in the main bedroom, behind the TV, in the ceiling. The button to turn the TV Signal Booster on and off is labeled “ANT POWER.” It is shown in the picture above.
- When viewing cable, satellite, watching a DVD, or playing a gaming system, The TV signal booster must be turned off. The signal booster signal can be picked up by the devices listed above and can cause issues with picture quality.



There is also an on and off button located to the right of the coax connection. This button is to turn the WiFi on and off. This button is utilized if the WiFi router is added in the aftermarket.

SEC.09 ELECTRONICS: AUDIO, VIDEO & THE RV CONTROL SYSTEM

9. Cable/Satellite Outlet

Cable and Satellite connection outlets can be located within the convenience center in the pass-through compartment. The picture on the right shows the location of the connections circled in yellow.



- The Cable input is transmitted through an RG6 coax cable that contains an in-line splitter that will allow the cable to be connected to multiple locations.
- The Satellite input is transmitted through an RG6 coax cable but DOES NOT contain an in-line splitter and is directly ran to each specific location within the RV. This allows for an uninterrupted transfer of HD signal from the satellite dish to the TV.

CONNECTING COAX FOR CABLE AND SATELLITE:

1. For cable, connect the threaded coax from the source to the “**CABLE**” connection.
2. For satellite, connect the threaded coax from the satellite dish to the “**SAT**” connection.

Please refer to the satellite manufacturer’s manual for information, instructions, care, and maintenance instructions.

+ NOTICE

A satellite dish is not provided with your RV and is purchased aftermarket.

10. TV Roof Antenna

To watch local TV stations, turn the TV and TV Roof Antenna power on.

Winegard AIR 360+ Operation



- AIR 360+ can receive VHF/UHF/FM frequencies while in a parked position from any direction up to 55 miles away.
- The antenna has 360 degrees of reception so there is no need to aim or point the antennae in the direction of the signal.
- The antenna is also internet ready and easily connects to the Winegard Gateway router for WiFi, 4G and GPS. See [Section 9B\(9\)](#) for additional details.
- You must run a Channel Scan on your TV to receive maximum programming.
- Ensure the antenna power supply is in the “**ON**” position and the green indicator light is illuminated. See [Section 9B\(8\)](#) above for details. It is located behind the bedroom TV.
- A secondary scan can locate and add any new channels found in your area as well as any channels that have been moved or changed.



CEILING MOUNTED ANTENNA POWER SUPPLY

11. Your unit may be equipped with a bedroom TV. To remove the TV from the supplied bracket follow the below steps. Be sure to disconnect power cord and any other connected cords from TV before this operation.



To reinstall TV line up sideways “V” shaped bracket on back of TV to the corresponding grooves on bracket attached to wall. Slide TV to the left until you hear TV bracket latch click and reengage. At this point the TV is now secured to wall bracket.

Pull up on nylon strap attached to TV bracket latch. Then slide TV to the right until it releases completely from bracket.



SEC.09 ELECTRONICS: AUDIO, VIDEO & THE RV CONTROL SYSTEM

While the steps to perform a channel scan may vary between televisions or compatible devices, below are some general guidelines to follow

HOW TO RUN A CHANNEL SCAN USING THE TV REMOTE:

1. Select “**Menu**” then select “**Settings.**”
2. Select “**Channel Setup.**”
3. Select “**Antenna**” or “**Air,**” depending on your TV. Make sure you are not on “**Cable.**”
4. Select “**Channel Search**” or “**Channel Scan.**”
 - a. The steps to perform a channel scan may vary.
 - b. If the wording on your TV differs from the options shown, refer to your TV user manual for help.
 - c. Running a Channel Scan is NOT the same as pressing **Channel UP/DOWN** on your remote.
5. To keep your saved channels up to date, it is recommended to run a Channel Scan:
 - a. Once per month.
 - b. When a channel is lost.
 - c. When you change locations.

+ NOTICE

The exact locations of local broadcasting towers can be found at: www.fcc.gov/reports-research/maps/dtv-maps/.

9. Gateway WiFi Router (Customer Supplied)

The Winegard Gateway 4G LTE WiFi Router (GW-1000) is an optional upgrade to the AIR 360+ antenna installed on the



RV. This router provides GPS and activates the pre-installed 4G LTE and WiFi antennas in your AIR 360+. Adding this upgrade provides you with an all-in-one solution for your internet, TV and AM/FM radio. The RV is prepped for this upgrade, but is an aftermarket purchase and is Customer Supplied.

For additional information or details, please contact your Dealer or visit winegard.com/gateway.

10. Furrion Back-Up Camera (If Equipped)

Your Model I travel trailer is prepped for installation of the Furrion Back-Up Camera. This camera is capable of being viewed with the supplied Furrion 7” monitor. The backup camera is wired to only have power when the RV is connected to the tow vehicle via the 7-way towing connector.



THE FURRION VISION S CAMERA

The Furrion Vision S camera offers a 65 to 20 degree viewing angle, night vision, motion detection and auto wake function for extra security when the RV is stationary. Most importantly, it is provided to help you safely back up your unit.

Please read both the manual for the Furrion Back-Up Camera and the Lippert Connect manual found in your Owner Information Package prior to downloading or using the Lippert Connect App and Furrion camera. You can also locate the Furrion Vision S camera owner’s manual online at furrion.com/collections/cameras/products/doorway-rear-camera.

C. NEBULA VIDEO PROJECTOR (IF EQUIPPED)

1. Your Model I may be equipped with a video projector in the living room. This ceiling mounted appliance takes the place of a TV, and projects the video signal onto either a screen for viewing inside the unit, or onto a specially coated window for viewing outside the RV. The projector operates with a remote.



2. Operating the Projector

The remote turns the projector on and off, and allows you to select streaming services, like Netflix®, YouTube®, and Amazon Prime®. For additional viewing options and full details of the features of your projector, scan this QR code.

PROJECTOR QR CODE



3. Operating the Opaque Window

The window at the dinesk can be used as a conventional clear window, or can be transformed into a video screen. The switch on the end of the dinesk cabinet will allow you to select a clear view of the outdoors, or with the flip of the switch, it becomes opaque for use as a video screen you can watch when outside the RV. The projector allows you to reverse the image for proper orientation of the picture being viewed when outside.

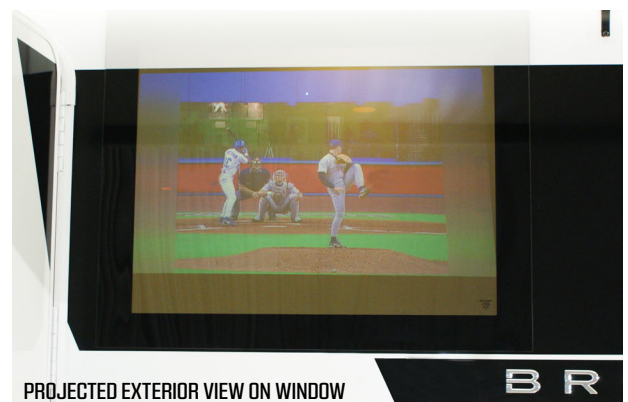
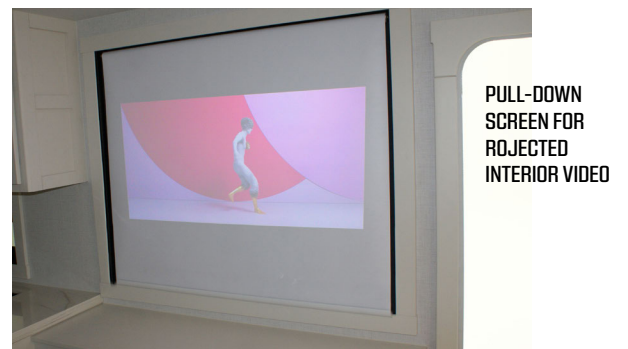

SEC.09 ELECTRONICS: AUDIO, VIDEO & THE RV CONTROL SYSTEM

D. RV CONTROL SYSTEM—LIPPERT ONECONTROL

1. RV Device Access and Operation

Your Brinkley Model I is equipped with a OneControl® Smart RV System. OneControl provides easy access to controls for awnings, slides, lights, water heaters and more. It displays information on RV resources like holding tank levels, battery health and the operational status of up to 23 electronic systems.

You may access the OneControl System inside your RV and from a mobile app.

2. Monitor Panel (Control Panel or Command Center)

For access inside your RV, look for the Monitor panel. It is located in the upper cabinet immediately inside the entry door and looks as shown (below). Along the top of the panel, you'll find holding tank levels (top left) and battery status (top right). **NOTE: Panel may vary by floorplan.**

Holding tanks report 4 standard levels: Full, 2/3, 1/3 and Empty. Battery status is displayed as Charged, Good, Fair and Poor. Because your RV is equipped with a Battery Monitor, status corresponds to a specific State-of-Charge (SoC):

- **Charged = 76% to 100%**
- **Good = 50% to 75%**
- **Fair = 20% to 49%**
- **Poor = 0% to 19%**

Located below holding tanks and battery status are buttons for RV devices.

The top two rows of the Monitor Panel provide access to devices like Lights, Water Pump and Water Heater. These provide **ON/OFF** functionality. When a device is turned “**ON**”, the button will change from white illumination to blue (see photo below).

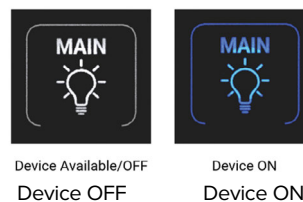

Buttons for Slides and Awnings are “momentary.” They activate the device only when the button is being pressed. When the button is released, the device returns to the “Off” position automatically. This provides safety by requiring the switch remain held by an operator during activation.

3. Mobile App

For greater convenience, all devices are available in the OneControl app. The app is available in the Apple and Android app stores.

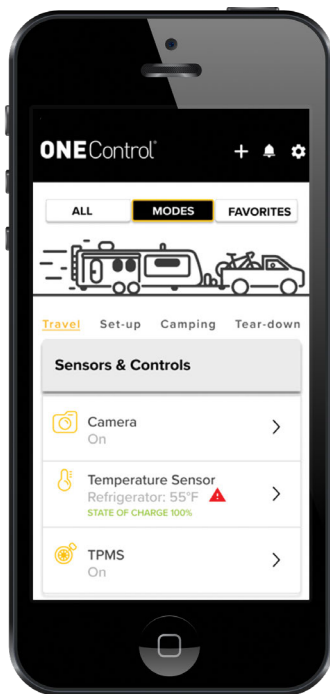

4. Pairing

To operate RV devices, the app needs to be paired with your RV.

TO PAIR YOUR RV:

1. Download the app, register as a user and accept the user agreement.
2. Then, stand near the Monitor Panel with the RV powered ON.
3. In the app, locate the “+” icon. Press it to open the “Add and Manage” page.

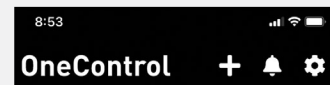

Tap the '+' icon to connect to your RV and devices.

4. Open the “RV Connection” page and select “Push to Pair”.

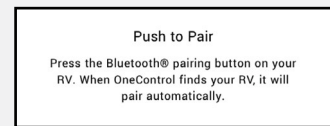

5. On the Monitor Panel, press the Bluetooth® button.

The RV’s OneControl System and the app will sync, allowing access to RV devices on the OneControl system. As many as 3 people may pair to the RV. Simply repeat the process for each user.

5. App Access

The app and the RV communicate via Bluetooth. Due to obstructions like walls, cabinets and frames, typical Bluetooth range is 30-40 feet. Explore your range by walking around the outside of your RV with the app open and connected to your RV.

6. App Functions

The app allows access to all devices available on the OneControl System. Along the top of the app are three options for device access.

SEC.09 ELECTRONICS: AUDIO, VIDEO & THE RV CONTROL SYSTEM

a. All/Home Page

The ALL page provides access to all devices and systems. Frequently used devices are displayed on the top as “widgets.” These include battery voltage, lights, HVAC and holding tanks. Below the widgets is the Device Library.

This includes a section for each group of devices, like lights. Many devices include essential functions on the ALL page, such as ON/OFF switches or Extend/Retract buttons. Whenever an arrow is present, the device includes additional functions. Tap the arrow to open the device’s home page to see available functions.



b. Modes

Modes allows you to customize device access based on where you are in your trip. For example, the devices needed during Set-up, like Slides, are often not required while Camping. Modes allows you to choose the devices you want quick access to at each part of your trip.

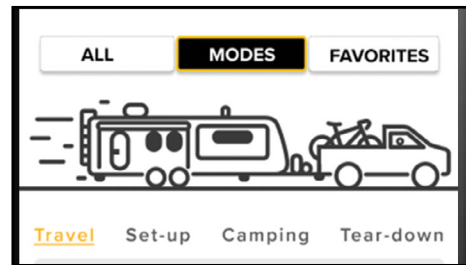

To personalize your Modes, open the page and select one of the 4 options:

TRAVEL, SET-UP, CAMPING or TEAR-DOWN

Scroll to the bottom to see your RV’s devices. Each Mode has been prepopulated with devices typically used during that activity. To change them, tap “Customize.” A short carousel will show you how to choose devices, change order and save. You can even add reminders to make sure you don’t miss a thing!

c. Favorites

Favorites operates like Modes but does not include a pre-populated list. It’s a blank canvas for you to customize.

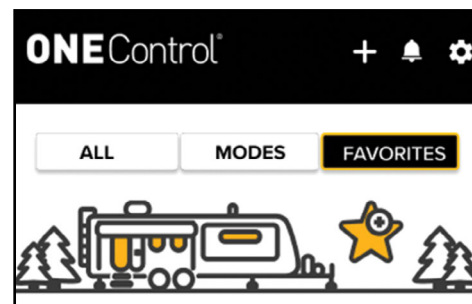

d. Battery Monitor

Your RV is equipped with a Battery Monitor. On the home page, the battery monitor widget will always show Voltage. The arrow on the lower right provides access to more detailed information on the Battery Monitor home page. The home page provides 3 types of battery information:

LIVE, STATS AND SETTINGS

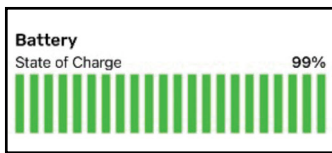

The **LIVE** page shows the status of the battery at that moment (provided the app is connected to the RV and the RV is powered “ON”). The lower right of the header shows the most recent time the app and the battery monitor synced.

The **STATS** section shows information about charging and discharging. Use this to keep an eye on overall battery health and history. Information icons (i) describes each section.

The **SETTINGS** page allows you to assign a name and record useful information such as the installation date. **SETTINGS** also allows you to set a notification, should Voltage fall.

SETTINGS includes an Idle Alert to remind you to disconnect your battery when not in use. This helps preserve battery health and state of charge, or SoC, by avoiding minor drains that can reduce SoC over time.

e. All Lights

This button allows you to turn all lights ON or OFF simultaneously.

f. RV Health Monitor

RV Health Monitor™ is designed to quickly display the status of your RV’s devices, provide tips on maintaining RV health and connect you with help when you need it.

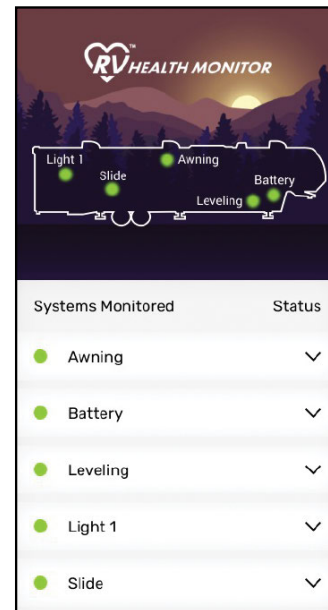

RV Health Monitor communicates with the OneControl devices on your RV. When your phone is within range of your RV and has a cellular connection, just open the OneControl mobile app. RV Health Monitor automatically scans information from OneControl devices and sends you a status update.

Depending on your RV’s configuration, RV Health Monitor assesses the status of up to 23 RV systems like awnings, lights, slides, and batteries. Device status is reported with colors: red, yellow, and green.

- If green, RV Health Monitor has assessed the device’s electronic controls to be functioning within normal operating ranges. The device should be available for regular use.

SEC.09 ELECTRONICS: AUDIO, VIDEO & THE RV CONTROL SYSTEM

- If yellow, RV Health Monitor has detected a variation in operating range that may benefit from close inspection or service. It may also mean a battery is severely depleted or is in poor health.
- If red, RV Health Monitor has diagnosed a condition that requires immediate attention.

In the event of yellow or red status, the RV Health Monitor includes recommendations for inspecting the device, then steps on how to resolve the issue.

Steps include tips, photos, videos and links to nearby Dealers or service centers. A Care Center is always a click away.

+ NOTICE

Even though RV Health Monitor can assess the performance of certain electronic controls inside a device, it's not able to see physical damage to the device or the RV.

Before taking a trip, inspect your RV and devices for excessive wear or damage. Always inspect devices according to manufacturer specifications or schedule an inspection with a qualified service center or technician.

g. Holding Tanks

Like on the Monitor Panel, Water Tanks are displayed in 4 levels: full, 2/3, 1/3 and empty.

h. Device Library

Below water tanks is the Device Library. This provides access to all OneControl devices. They are sorted into categories and displayed alphabetically, with the exception of Lights, which are listed first.

+ NOTICE

Only OneControl devices will be displayed in the OneControl app. Your RV may be equipped with devices outside the OneControl system. These will not show up in the app.

i. Auto Set-Up

Your RV is equipped with Auto Set-up. Auto Set-up allows you to create an automated sequence of devices, like leveling, lights, awnings and more.

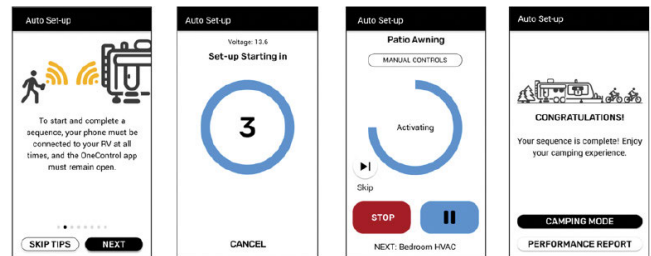

+ NOTICE

RV industry safety standards require that slides must be activated manually.

Auto Set-up includes a short video to help you create your sequence. It shows you how to select and change the order of devices, create reminders, and save your sequence. When you're ready to run a sequence, Auto Set-up includes tips for successful operation, including notes about maintaining phone-to-RV communication and safety.

A. INTRODUCTION

Within this section you will find information on the original heating and cooling (HVAC) components installed within your RV at the Brinkley factory. Please know that if any of these components were replaced after the RV left the factory as an aftermarket installation, this information does not apply to those aftermarket items. For additional information, please refer to the manufacturer’s manuals found in Owner Information Package or visit their direct website. In the circumstance of an aftermarket modification or installation has been performed on your RV, please contact the servicing Dealer who performed the work for additional information.

B. DUCTING AND RETURN AIR

Adjustable registers and vents are designed and intended to **REDUCE** and adjust airflow, not to fully inhibit air flow. Heat registers must remain free and clear of any obstruction that may inhibit airflow from passing through the air return. Care should also be taken to ensure that debris and other small items do not pass into the air returns.

⚠ CAUTION

Do not operate the air conditioner without the proper return air filter. Operation without this filter will allow debris to pass through and accumulate on the cooling coils. Over time, this will lead to loss of efficiency in cooling, air volume loss, equipment damage, and professional cleaning expenses.

C. AIR CONDITIONER (A/C)

The thermostats within the RV control the roof-mounted A/C systems installed on your RV. The air conditioning unit(s) are located on the roof of your RV. Note that two A/C units are standard from the factory. The picture below is of the Furrion A/C Cool Cube unit in a Model I Travel Trailer living room. will be located near the entry door of the RV and in the bedroom of the RV.



+ NOTICE

Registers should NEVER be fully closed and NEVER fully obstruct the airflow.

Sufficient power is vital for proper operation of the air conditioner(s) to ensure they are able to efficiently cool the RV as well as to prevent damage to the components of the A/C system.

Note that the main living A/C unit is a “direct drop” system. This means that the air drops directly from the A/C into the room from the ceiling without being ducted. The A/C unit in the main bedroom is a “direct drop” system for the bedroom, but is also ducted into the bathroom.

SEC.10 HEATING & COOLING (HVAC)

The layout of the A/C units will vary from floorplan to floorplan. In some floorplans, all of the A/C units may be ducted. In others, there may be a combination of ducted and direct drop systems utilized. When designing the RVs, we look to maximize air flow and create the most efficient setup to ensure that the A/Cs work as efficiently and effectively as possible.

If you have any questions related to your specific floorplan, please do not hesitate to contact Brinkley Customer Care and one of our specialists will explain the specifics to your particular floorplan.

There are several important facts to know about RV A/C units:

- 1) The A/C units are all powered by 120VAC. This means they are able to be utilized when there is sufficient 120VAC power being supplied to the unit. Utilization of the shore power cord to provide power is the most effective means of operating the A/C units.
- 2) If you elect to add an inverter to your RV, please note that the inverter will not be able to produce sufficient power to operate the A/C units. Given that the inverter would utilize power from your on board battery, it will not be capable of supplying the amperage required to operate the A/C units.
- 3) Another alternative would be to add a generator into the front compartment or utilize a portable generator plugged into the shower power inlet. Generators, assuming they are appropriately sized for your RV, can provide sufficient 120VAC to operate the A/Cs.
- 4) As your unit is built and equipped from the factory, the A/C units can only be utilized on shore power. Boondocking or camping off grid would mean that you will not have the ability to run your A/C units without generator power.
- 5) RV A/C units are typically only capable of cool-

ing the RV down by 20 to 25 degrees Fahrenheit below the ambient air temperature. Therefore, in extremely hot climates, your A/C units may not be able to cool the RV to your desired temperature.



The bedroom thermostat is located just inside the bedroom door on the bathroom wall.

1. Cooling vs. Heat Gain

The A/C on the RV is designed to cool intake (outside) air by approximately 20-25°F. Please know that environmental surroundings, the location of your RV, and other conditions may affect the efficiency in performance of the A/C. When located in hot climates and little or no protection to the RV (no trees or surrounding shade), the RV will absorb the heat from the sun and increase the temperature inside the RV. This process is referred to as “heat gain.”

Reducing the RV heat gain is important to obtain a comfortable temperature inside the RV. Following the below instructions will help to reduce heat gain within your RV.

REDUCING HEAT GAIN:

1. Park the RV in a shaded area with plenty of airflow.
2. Close all the blinds.
3. Keep all doors and windows closed.
4. Extend the awnings to provide additional shade.
5. Avoid the use of heat producing appliances such as the oven or stove top.
6. Set the A/C mode to high. When encountering high humidity or high temperatures, this will help provide maximum cooling efficiency.
7. Turn ON the A/C as early in the day as possible. This will allow the A/C to cool the RV prior the outdoor temperature rising throughout the day.

2. Air Conditioner Gasket

Between the roof material and subframe of the A/C, there is a foam gasket that acts as a weather-proof seal. Because the A/C is subjected to wind pressures and motor vibrations, this seal should be inspected every six months. To inspect the gasket,

you must remove the air distribution box located in the interior ceiling in the location of the A/C unit. The picture below shows what the A/C distribution box cover looks like for reference. Check for leaks and re-tighten any loose mounting bolts as needed. Be careful to not to over-tighten the mounting bolts. Doing so may result in the seal becoming damaged.



Over time, the A/C gasket will need to be replaced. To gain access to the mounting bolts, the A/C shroud and filter from inside the RV will need to be removed. From there you will be able to carefully remove the bolts and gain access to the seal itself.

D. FURNACE

The thermostat within the RV controls the function of the furnace installed in the RV. The thermostat is located in the interior of the RV near the main entry door of the RV. The second AC thermostat generally is located in the master bedroom. A picture of the thermostat is provided below. For full operation, the furnace requires both 12-volt power and propane gas. Sufficient power is required to properly function the furnace.



SEC.10 HEATING & COOLING (HVAC)

The furnace itself is in the sidewall of the RV on the door side of the unit and in between the water heater and 50-amp power receptacle. The picture on the right shows the location of the furnace. For additional information pertaining to the operation, maintenance and troubleshooting of the furnace, please consult the manufacturer's manual.

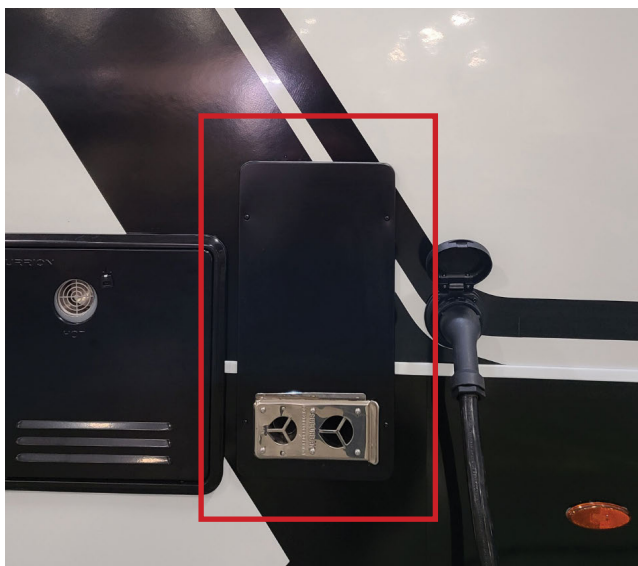

+ NOTICE

Never attempt to repair a furnace if it is not functioning properly. Furnace maintenance should always be completed by a qualified technician. Only OEM parts are to be used when parts are needed. Inspection and maintenance should be performed on an annual basis, or more frequently if heavily used. Please contact your Dealer with further questions, concerns, or to obtain service.

⚠ WARNING

Do not obstruct airflow going to or from the furnace for any reason and do not modify the installation. Doing so will cause unsafe furnace operation and ultimately can lead to damage to the furnace, personal injury, or fire.

E. FIREPLACE (IF EQUIPPED)

Your RV may have a fireplace (If Equipped) in the main living area. A picture of the fireplace is provided (below). The control panel is located in the upper right hand of the fireplace as indicated by the red circle on the photo. These control buttons permit you to change the lighting, heat intensity, and to set a timer so that the fireplace shuts off automatically. The provided remote also provides control of all features.



The Power Button

The power button turns the fireplace on and off. Once on, if the fireplace display is not illuminated, pressing the power button will light up the display. The power button has a built-in memory function that will retain the status of the fireplace when turned off. With the exception of the timer, the fireplace will restart in its previous status. If the fireplace is disconnected from the main power source, it will lose the memory and restart at the default settings.

The Flame Button

Each time the Flame Button is pressed, the colors of the flame and ember bed changes. There are 3 colors (display will show L2, L3 or L4), dynamic condition (display will show L1) that rotates through all of the colors, and the flame OFF setting you that can cycle through.

The Heater Button

The Heater Button turns the heater on and off. When the heater is on, press the Increase Decrease button to change the desired temperature. There are 11 temperature settings that range between 64 – 84 degrees Fahrenheit (17.8 – 28.9 degrees Celsius).

Temperature unit conversion function:

When the heater is on, press and hold the Power Button for 5 seconds, current temperature unit display will flash 3 times and convert the temperature from F to C and vice versa
Note: This cannot be set with the remote control).

Lock and unlock heater function:

Press and hold the Heater Button for 10 seconds, the ember bed will flash 6 times, indicating that the heater function is locked. To unlock the heater function, just repress and hold the heater icon for 10 seconds again, then the ember bed will also flash 6 times indicating the heater function is unlocked (Note: This can't be set with the remote control).

The Timer Button

The TIMER has adjustable setting with range from 1 hour to 8 hours (in 1-hour increments) and OFF. Once you have set the timer, and the timer is up, it will shut off all functions and enter standby mode. In this mode, you must touch the power icon to restart the fireplace.

The Increase/Decrease Button

When the heater is on, press the Increase/Decrease button to change the desired temperature. Please refer to the manufacturer's manual for instructions, operation, warnings, and maintenance information. Please contact your Dealer or Brinkley Customer Care if you have any questions or concerns.

SEC.10 HEATING & COOLING (HVAC)

F. ROOF VENTS

Roof vents are installed on the RV to allow for additional airflow within the RV. These vents may be manual or electric. Make sure all vents are closed while the RV is in transit, or if weather conditions are poor. The main living room roof vent is fully powered. The remote access to open/close the vent and operate the fan is located in the cabinet door just inside the entry door where the control panel is located as shown in the picture below.

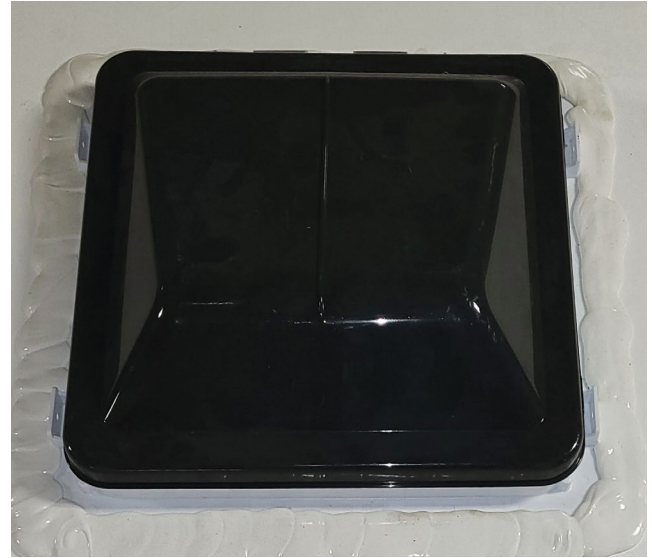

The bathroom vent is operated via the same control type as the kitchen and is located on the main bathroom wall.

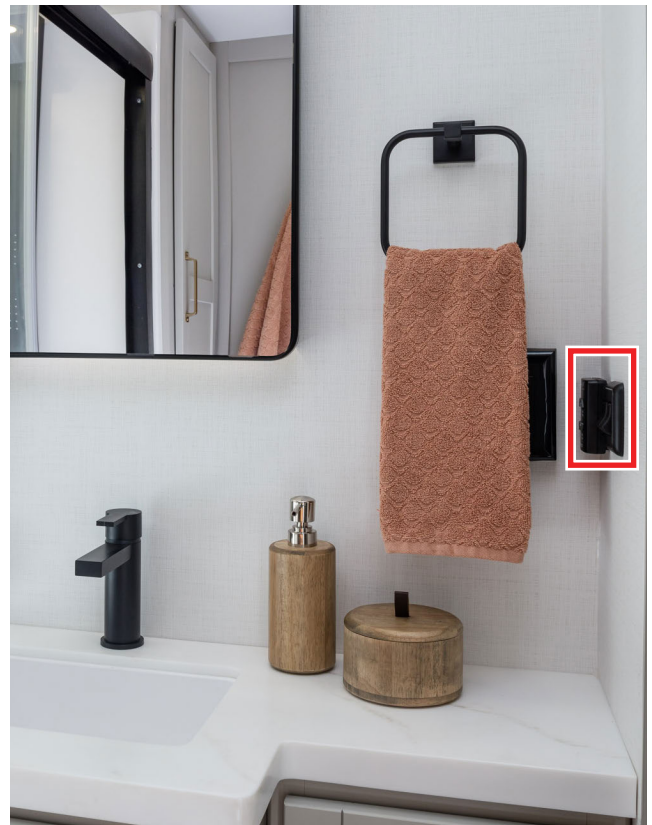

SEC.11 APPLIANCES

A. GENERAL INFORMATION

Before using any appliance in the RV, it is best to read and understand all instructions, warning, and safety alerts provided within the manufacturer's manual of each appliance. These manuals can be found within your Owner Information Package.

If you happen to have additional questions or concerns, please do not hesitate to contact your Dealer or Brinkley RV Customer Care.

In the circumstance where aftermarket modifications have taken place within the RV, the provided instructions within this manual may not apply. In this occurrence, please contact the service center who provided the service for additional information and assistance.

DANGER

NEVER USE GAS OPERATED COOKING APPLIANCES IN ATTEMPT TO OBTAIN HEAT FOR COMFORT.

This form of use may lead to carbon monoxide poisoning, resulting in sickness, serious injury, or death.

IF YOU SMELL PROPANE:

1. Extinguish all open flames, pilot lights, smoking materials, etc.
2. Refrain from touching any electrical switches.
3. Shut off the propane supply the LP bottles.
4. Ventilate the RV by opening all doors, windows, and vents.
5. Remain at a safe distance from the RV until all odor clears.
6. Have the propane system inspected and repaired as needed before continuing use.

Failure to comply with these instructions may result in explosion of the RV leading to serious injury or death.

B. MICROWAVE

To utilize the microwave, sufficient 120-volt power MUST be available. To prevent damage, ensure the glass turntable within the microwave is properly secured before traveling. In RVs that do not have a range hood, the microwave vent is utilized in place of the range hood.



For additional information, please refer to the manufacturer's manual.

C. 12-VOLT REFRIGERATOR

The refrigerator within the RV is not intended for rapid cooling. Expect the refrigerator to take roughly 48 hours to reach maximum cooling potential. For best results, please see the following recommendations. It is best to stock the freezer with already frozen foods and cold items within the main compartment.



- At a minimum, the refrigerator should be inspected bi-annually.
- Repairs should always be performed by a certified or authorized service provider.

- Stock the freezer with already frozen foods.
- Place chilled items in the cooling compartment.
- Arrange food so air can still circulate.
- Never cover the shelves with materials (i.e., cloth, paper, plastic, etc.).
- Keep the back section of the refrigerator clean and free of clutter, spills, and debris.
- Regularly have the refrigerator inspected and repaired as needed.

SEC.11 APPLIANCES

D. COOKING WITH PROPANE

For safety instructions, please see [Section 12](#) and the component manufacturer's manual.

GREASE FIRES:

Grease is highly flammable. Always clean burners so grease does not collect on top of the cooking surface or around the burner. If grease is spilled, clean it up immediately before continuing cooking. If a fire ignites, follow these safety rules:

1. Evacuate the RV immediately and make sure everyone is accounted for. Have everyone remain at a safe distance until the fire is extinguished.
2. Once everyone is at a safe distance, safely attempt to extinguish the fire.
 - a. First eliminate the fuel source by shutting off the oven or burner.
 - b. Attempt to smother the fire with a cooking lid.
 - c. Extinguish with baking soda or a multipurpose dry chemical extinguisher.
3. Never pick up a flaming pan. This can cause the fire to quickly spread if the pan is dropped or if the grease is spilled.
4. If the fire cannot be easily extinguished, your safety is priority. Immediately return to a safe location that is clear of the RV and call 911 to have the Fire Department handle the emergency.

⚠ DANGER

Never use portable fuel operated cooking equipment inside the RV (i.e., portable grills, stove tops, etc.). Use may lead to the build-up of carbon monoxide, inability to properly breathe, damage, personal injury, and fire.

E. COOKTOP

Your Model I is equipped with a cooktop mounted in the kitchen counter. and utilizes propane gas. When selecting pan sizes, please refer to the manufacturer's recommendation. By following the recommended pot and pan sizes, you will improve cooking efficiency, lessen the risk of injury, and lessen the risk of damage. The pan should be large enough to cover the burner range, but no more than one inch larger than the burner grate itself.



⚠ WARNING

NEVER leave cooking food unattended. Turn pan handles inward, but not over the tops of the other range burners. Ensure that pans used are large enough to contain the food and avoid boil-overs. Heavy splattering or spills left on the cook top can ignite and cause burns.

SEC.12 PROPANE (LP) SYSTEMS

A. GENERAL INFORMATION

The propane system within the RV includes all gas related appliances, propane cylinder(s), propane regulator, and all plumbing going to and from the LP cylinders to the appliances. Please see all the related manufacturer's manuals for additional information, instructions, and safety precautions.

DANGER

STOP IMMEDIATELY if you smell propane! Quickly and carefully perform the 6 steps provided in the instruction box below in [Section 13C](#).

B. MAINTENANCE

Although the propane system is carefully inspected by both Brinkley RV and your selling Dealer, the propane system should continuously be inspected and repaired as needed. While in transit, fittings can loosen due to the vibration of the RV while being towed or moved.

As a safety precaution, the RV's propane system should be inspected immediately upon purchase, after the LP tanks are initially filled, and after the first 5,000 miles traveled. Continuous LP inspection is part your normal RV maintenance and should also be completed on an annual basis by your Dealer or a qualified service technician.

DO NOT REMOVE THE FOLLOWING LABEL FROM YOUR RV:

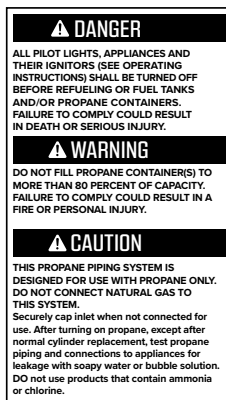

C. PROPANE GAS

Propane (also referred to as LP) is widely used within your RV by appliances including, but not limited to, the stove, cook top, furnace, and hot water heater.

Ethyl Mercaptan, an unpleasant chemical with the odor of "sulfur or rotten egg," is added to propane as a warning agent. Upon smelling this odor, it should alert you that LP is present and there is a possible leak creating a safety hazard.

When an LP tank is low in fuel, you will notice a different odor, one more like onion or garlic. As soon as the tank is refilled, this smell will dissipate. Commonly, this odor is mistaken as a gas leak. Be cautious of this and be aware of the different smells present with LP.

If you notice the odor persists, turn OFF all the gas operated appliances, shut the LP tank valves, and contact your Dealer or a qualified service facility to inspect the LP system.

DANGER

IF YOU SMELL PROPANE:

1. Extinguish all open flames, pilot lights, smoking materials, etc.
2. Refrain from touching any electrical switches.
3. Shut off the propane supply at the LP bottles.
4. Ventilate the RV by opening all doors, windows, and vents.
5. Remain at a safe distance from the RV until all odor clears.
6. Have the propane system inspected and repaired as needed before continuing use.

Failure to comply with these instructions may result in explosion of the RV leading to serious injury or death.

D. PROPANE GAS CYLINDERS

1. General Information

Propane cylinders, commonly referred to as LP bottles, are utilized for the storage and delivery of propane gas (LP) to the LP operated appliances within the RV. It is required for all propane cylinders to be filled at a qualified propane fill station and are filled by weight. While under pressure in the LP cylinder, the LP is in liquid form. As propane is released from the LP cylinder, it immediately transforms back into a gaseous state before reaching an appliance. The state of the LP is managed by an LP regulator found within 24 inches (60.96 cm) of the LP cylinder.

⚠ DANGER

Propane EXPANDS 1.5% for every 10 degrees Fahrenheit increase in temperature. Sufficient space within the LP cylinder must be left empty to allow for the expansion of gas during warmer weather. Failure to leave sufficient space may result in the cylinder exploding leading to property damage, RV damage, personal injury, or death.

While the propane system is not in use, the propane cylinder valves **MUST** be closed to keep LP from being released. To fully shut off the LP, turn the valve found at the top of the propane cylinder clockwise. To open the LP valve, turn the valve counterclockwise. LP cylinder valves should always be hand tightened. Tools should never be used when opening or closing the LP cylinder valves. Over-tightening this valve may lead to damage of the internal seal which will cause them to improperly seat. If the seals are incapable of seating correctly, the valve will not be able to properly close and as a result will allow LP to leak.

The LP cylinders provided with the RV are DOT (Department of Transportation) Cylinders. Every DOT cylinder is equipped with an overfill protection device (OPD) and Acme Type 1

propane connector. Also, the valve can easily be identified by their triangular knob shape. Before traveling with or storing the RV, ensure this valve is fully closed on the tank.



When removing the cylinders to fill, always reinsert them in the proper orientation. Typically, DOT cylinders have an arrow and label signifying “top” to indicate the correct orientation of how the cylinder(s) should be installed.

+ NOTICE

LP cylinders should always be mounted, stored, and transported in the correct specified position. When traveling they should be securely fastened using the straps provided by Brinkley RV.

Each LP cylinder is connected by the thermal Type 1 Acme Pigtail, you will also find a two-stage regulator to monitor the pressures of LP released. The pigtail assembly is a wrenchless system and should only be hand tightened when needed.



SEC.12 PROPANE (LP) SYSTEMS

⚠ WARNING

Because propane can quickly expand, a pressure release valve is installed on the cylinder so that gas can discharge as pressure builds. If gas is discharged, it will be released into the surrounding environment. Propane cylinders should never be stored indoors or inside the RV.

2. Servicing or Filling

Upon purchasing the RV and as the tanks are filled, the propane system should be inspected for leaks.

⚠ WARNING

When filling tanks, only the qualified service representative should be near the RV. Make sure all parties are at a safe distance and not within the RV.

When an LP cylinder is being filled for the first time, make sure a qualified representative purges the cylinder of any trapped air. If the cylinder is not purged, an imbalanced mixture of air and gas may occur making it impossible for propane appliances to light.

⚠ WARNING

PRIOR TO arriving at a propane fill station, be sure all pilot lights are extinguished and all LP appliances are shut off. Always turn off the engine of the tow vehicle before fueling. Never smoke or operate other ignition sources while fueling.

3. LP Gas Container Overfill

⚠ WARNING

If you suspect an LP Cylinder has been over-filled, remain at a safe distance and contact your Dealer or a qualified propane technician immediately for assistance. Never attempt to service an over-filled LP cylinder.

4. Propane Leak Test

Test for leaks with a water and soap solution

TESTING FOR LP LEAKS:

- Mix the solution and spray all joints and fittings of the gas line.
- When a leak is present, the soapy solution will bubble.
- Small bubbles tend to indicate smaller leaks and larger bubbles indicate larger leaks. Neither should be ignored.

If a leak is present and is not corrected by tightening the connection, shut off all LP and LP appliances and contact your Dealer immediately.

+ NOTICE

Never use an ammonia or chlorine-based solution. Both can cause corrosive damage to the gas lines and fittings.

⚠ WARNING

Never use an open flame to test for leaks. Doing so may result in fire or explosion leading to serious damage, injury, or death.

5. Propane Gas Alarm

Each RV is equipped with a Propane Gas Alarm. Please see [Section 4G](#) for additional details. Please also refer to the manufacturer's manual.

6. Installing the Propane Cylinders

Correct positioning of the LP cylinder(s) and all related hoses and fittings is vital for the proper operation and flow of propane

INSTALLING LP CYLINDERS:

1. **ENSURE** all fuel fed appliances are shut **OFF**.
2. **ENSURE** the LP cylinder valve is **CLOSED**.
3. **CONNECT** the 3/8" low-pressure hose to the outlet of the two-stage regulator.
4. **PLACE** the LP cylinder on the LP bracket in the designated compartment and secure the tank in place using the provided straps.
5. **MOUNT** the regulator on the back wall centered to the compartment so the vent is pointing downward.
6. **ATTACH** the Type-1 pigtail hose to the regulator and hand tighten.
7. **ATTACH** the main supply hose from the regulator to the brass manifold fitting in the frame of the RV. The swivel brass nut on the main hose will be your final attachment.

DANGER

The Propane Gas Alarm should be tested before every use of the RV and at least once a week throughout the trip.

WARNING

Never remove power from the alarms to silence them.

WARNING

To prevent tension and strain, a 12-18" Type 1 Acme Pigtail must be installed. Keep the pigtail hose free and clear from sharp edges and objects.

REINSTALLING AN LP CYLINDER:

- Inspect and tighten fittings as needed. Use the soap and water solution to test.
- Slowly open the main shut-off valve on the LP cylinder to prevent the propane from freezing up.
- If the propane freezes up, immediately close the main LP valve and wait at least fifteen (15) minutes before attempting a second time. For more information, please refer to the regulator manufacturer's manual.
- Listen for a hissing sound as the main valve is opened. If this sound last longer than a second, quickly shut the valve. This is an indication that there may be a leak. If you suspect a leak and it cannot be found, contact your Dealer or a certified service location for assistance.
- **REINSTALL** all protective covers and caps that were removed from the LP system.

WARNING

Ensure that all fasteners and safety straps are secured before traveling.

SEC.12 PROPANE (LP) SYSTEMS

E. PROPANE REGULATOR

The dual two-stage automatic LP Regulator is located under the LP tank cover on the front A-frame. The purpose of this regulator is to reduce the pressure of the LP coming from the LP cylinders to a consistent and safe pressure as well as allow the convenience of switching from one LP cylinder to the reserve LP cylinder when empty.

The first stage of the regulator reduces the LP pressure down to 10-13 psi (68.95 to 103.42 KPa). The second stage of the regulator further reduces the pressure to an operating pressure of 11" W.C. (water column).

For efficient performance, the second stage of the regulator should be adjusted by your Dealer or qualified service representative using a calibrated manometer.

- When the pressure is too high, safety and performance will be affected with the LP system.
- When pressure is too low, the operation of the LP appliances will be affected and may not operate or operate correctly.

If your RV contains an automatic two-stage regulator and both LP cylinders are full, turn the lever found on the regulator towards the LP cylinder you would like to use first. The chosen LP cylinder will be the primary tank utilized and the other will be the reserve.

Once the primary LP cylinder is determined with the regulator lever, slowly open the LP cylinder valve. The indicator found at the top of the regulator will change to green once the LP makes its way to the regulator. Once the primary LP cylinder becomes empty, as long as the reserve valve is open, the regulator will automatically change over and begin to pull from the reserve tank. It is recommended to keep the reserve tank valve closed so you become aware when the primary tank is empty.



If you choose to do this, the indicator will turn red when the primary tank becomes empty.

At that time, turn the lever on the regulator to the opposing side and open the valve to the second tank. As soon as LP hits the regulator, the indicator will once again turn green. Once the LP begins to pull from the reserve tank, the primary LP cylinder can be removed to be refilled. This can be completed without interrupting the flow of LP from the reserve cylinder. After the LP cylinder is refilled, remember to reconnect the pigtail line, secure the LP cylinder with the provided straps, and slowly open the cylinder valve, then check for leaks.

+ NOTICE

When the indicator on the LP regulator is RED, the LP tank is empty. If the indicator is GREEN, LP is still being supplied.

⚠ WARNING

Installation of new LP tanks, and vibration from travel can cause fittings to loosen over time. Frequently inspect the LP system for leaks and loose fittings by spraying connections with soapy water. Bubbles will indicate leaks. Failure to inspect the LP system may lead to gas leak resulting in fire or explosion.

⚠ WARNING

Two-stage propane regulators must be installed with the regulator vent facing down. Regulators found outside of the storage compartment are equipped with a protective cover. These regulators must also be installed with the vent facing down and the cover must remain in place to help minimize the possibility of the vent becoming blocked. If these instructions are not followed, vents may lose their efficiency or become obstructed leading to the buildup of excessive gas pressure and as a result cause fire or explosion.

F. PROPANE SYSTEM HOSES, TUBES, PIPES, AND FITTINGS

The hoses, pipes, tubes, and fittings that comprise the propane system are designed to handle pressures exceeding what the overall propane system is designed and intended to handle. The purpose of this is to provide additional safety within the overall LP system.

Because components will deteriorate over time, particularly when exposed to the elements, all components should be continuously inspected for wear and tear as suggested. LP hoses should be inspected prior to every use for cracks, durability, and flexibility. If cracks are present or durability and flexibility has been lost on the line, refrain from using the LP system until the line can be replaced.

When replacing an LP line or component, do so with components of the same nature, type, and rating. Never replace components with substitutions not suitable for the LP system. Always verify components with your Dealer if you are not sure.

The fittings utilized within the LP system connect all the various components found within the system. The fitting found at the end of the propane supply hose is made of brass and is known as a POL fitting. The threads within the fitting are left-handed threads which means you

would turn counterclockwise to tighten, and clockwise to loosen. The nature of this fitting allows it to prevent leaks from occurring without the use of pipe sealant and is designed to reduce the flow of LP in the event the regulator fails or hose malfunctions.

G. COOKING WITH PROPANE

Because an RV is much smaller than a common house, oxygen within the RV is limited. Any time a LP appliance is used within the RV, such as a cooking appliance, the RV should be properly ventilated to avoid the danger of asphyxiation. For additional safety instructions and information please see [Section 12](#).

H. TRAVELING WITH PROPANE

PRIOR TO TOWING THE RV:

1. **ENSURE** the propane cylinders are properly seated and fastened with the supplied straps.
2. **SHUT OFF** all LP fueled appliances.
3. **CLOSE** the valve found at the top of the LP cylinder.

Make sure you know the local laws regarding LP systems and transportation. State laws vary depending on location (i.e., tunnel and bridge laws when traveling with LP). Know this information before traveling in that given state.

⚠ WARNING

NEVER operate the propane system while the RV is in motion. Unpredictable weather conditions may pose great threat to the LP system if the provided instructions are not followed. For example, wind currents may cause flame reversal in the hot water heater or cooking appliance which could lead to fire or explosion.

SEC.12 PROPANE (LP) SYSTEMS

I. OPERATING THE PROPANE SYSTEM

Once the RV is fully set up and prepared for camping, please refer to the following steps for proper operation of the LP system.

OPERATING THE LP SYSTEM:

1. **ENSURE** all burners, controls, and pilot lights are shut off.
2. **OPEN** the main valve on the LP cylinder **SLOWLY** to prevent an LP freeze-up from occurring. If a propane freeze-up occurs, immediately close the valve and wait at least 15 minutes and then try again.
3. **LISTEN** carefully as you open the valve and as propane begins to flow. If the hissing sound of LP rushing through the lines lasts more than a second or two, quickly shut the main valve and contact your Dealer. In this occurrence, most likely there is a leak.
4. **OPERATE** the LP appliances **ONLY** as directed in the appropriate manufacturer's manual.

+ NOTICE

About LP Freeze Ups: As the liquid propane expands to a gas form and reaches its boiling point, it commonly freezes the available humidity around the regulator. This form of freezing isn't cause for concern. However, in extremely rare cases, the propane can "freeze" and remain in a liquid state as it passes through the regulator.

Prior to operating the propane system, please read and understand all instructions, safety requirements, warnings, and labels found within this document and the provided manufacturer's manuals found within the Owner Information

Package.

If you have additional questions or concerns, please contact your Dealer, the component manufacturer, or Brinkley RV Customer Care.

J. CALCULATING PROPANE USE

To determine how long the propane supply will last on your RV, use the BTU rating for each LP appliance. Propane consumption will vary depending on the length of use and the BTU used by the component. To calculate supply, take the BTU remaining in the LP cylinder divided by the BTU of the given appliance.

As reference, each gallon of propane (3.86 liters) produces roughly 91,500 BTUs of heat energy. If the furnace uses 16,400 BTU/Hr. and the LP cylinder has one gallon of propane, the calculation would be as follows: $(91,500 \text{ BTU}) / (16,400 \text{ BTU}) =$ approximately 5-1/2 hours of use.

$$\frac{(\text{Gallons of Propane} \times 91,500 \text{ BTU})}{\text{Appliance BTU}} = \text{Supply of BTU in Hours.}$$

Many of the LP appliances operate intermittently to prevent over-consumption of fuel. For example, unless the hot water heater is heavily used, the consumption of LP by the hot water heater is minimal. Be aware that cold weather and high winds can increase LP consumption of the gas appliances.

APPLIANCE	AVERAGE BTU CONSUMPTION/HR.
WATER HEATER	60,000 (RUNNING WATER THE WHOLE HOUR)
FURNACE	6-12 AMPS
RANGE W/OVEN	7,100
RANGE - REAR BURNER	6,500
RANGE - FRONT BURNER	9,000

SEC.13 PLUMBING SYSTEMS

A. INTRODUCTION

There are two water systems utilized on the RV:

1. The Fresh Water System
2. The Wastewater System

- **The Fresh Water System** includes the freshwater holding tank(s), freshwater connection, water heater, water pump, exterior spray ports, faucets, and water purification system (If Equipped).

- **The Wastewater System** consists of the gray and black water holding tanks, drains, drain lines, and toilet.

Prior to each trip or before the RV is stored, the following items should be inspected for leaks:

- All fresh and wastewater system lines and fittings.
- All faucet connections and its draining system.
- The water pump and water heater plumbing and connections.

At the end of each trip, the fresh tank should be drained and the waste tanks, both gray and black, should be properly emptied.

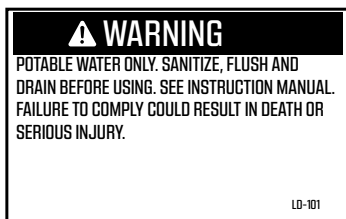

DO NOT REMOVE THE FOLLOWING LABEL FROM YOUR RV:

⚠ WARNING

Do not drink or consume water of unknown quality or that is deemed unsanitary or unsafe.

B. FIRST USE OF THE FRESH WATER SYSTEM

If your RV has been winterized from the factory, there will be a label placed on the entry door signifying “This Unit Has Been Winterized.”



WINTERIZATION LABEL:

Even if the RV has not been winterized, the water system should be sanitized prior to the first use. Sanitizing the water system in the RV will kill unwanted bacteria and organisms that may contaminate the water supply.

Please know that small amounts of contaminants and minerals are found in all water supplies. Even small amounts of contaminants can cause the freshwater to have an odor over time.

Please see [Section 13N](#) on how to sanitize the Fresh Water system.

C. MONITOR PANEL

Just inside the RV entry door, you will find the monitor panel in the cabinet. This monitor panel contains many controls for the lights, slides, and awning, and will display the fill levels of the fresh, gray, and black water holding tanks.



The yellow circled portion of the monitor panel shown on the previous page indicates the holding tank level information. In addition, it also will display voltage of the auxiliary battery. The battery charge information is shown on the portion of the panel circled in blue.

The monitor panel operates on 12-volt power that can be either supplied by the auxiliary battery or by the converter. No power is drawn from the battery unless a button is pushed to wake up the panel. Fuses for the monitor panel are in the load center.

D. WATER PRESSURE REGULATOR (CUSTOMER SUPPLIED)

Some RV parks, especially those in mountainous regions, have excessive water pressures that exceed the pressure limits of what the RV water system is capable of handling. If the RV is not properly protected, the water system can be compromised and/or damaged. To prevent possible damages, it is recommended you purchase a water pressure regulator. This is a Customer Supplied item and can be purchased through your Dealer.

+ NOTICE

Excessive water pressures may cause the O-rings within the water system to fail if a water pressure regulator is not used. It is recommended for a water pressure regulator rated 45 PSI be utilized when filling with city water. This is a Customer Supplied item and is not supplied with the RV.

E. WATER PUMP SWITCH

Once the water pump is turned ON, it will run until there is 45 PSI (310.26 kPa) within the waterlines. Once the pump achieves a pressure of 45 PSI it will automatically shut off. The water pump is an on-demand pump and will run anytime the pressure in drops below 45 PSI.

F. 12-VOLT WATER PUMP

The water pump is located behind the pass-through storage compartment access panels. Once the on-demand water pump is activated, it will self-prime and provide water. It will continue to run even after the water is shut off until it builds approximately 45 PSI of pressure within the waterlines. The water pump contains a built-in check valve that will not allow water to back flow and will automatically restart if pressures drop within the water lines.

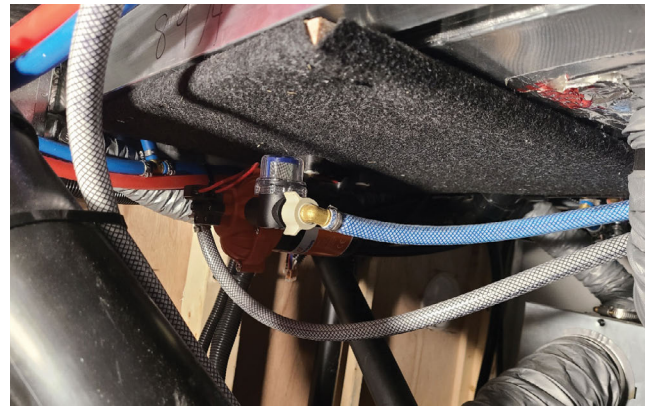

The water pump filter (If Equipped) is a reusable screen-type filter that is located on the inlet side of the fill. This filter should be periodically cleaned as needed.

+ NOTICE

When filling the fresh holding tank, do so with caution and DO NOT leave the tank unattended while filling. It is important to never overfill the tank. When a tank is overfilled, it causes excess pressure to build within the tank that may lead to leaks and water damage. Such damages are not warrantable and can be costly.

SEC.13 PLUMBING SYSTEMS

G. FRESH WATER HOLDING TANK

To fill the freshwater tank, do so using the freshwater inlet referred to as the city water inlet. The picture (below) shows the city water inlet.

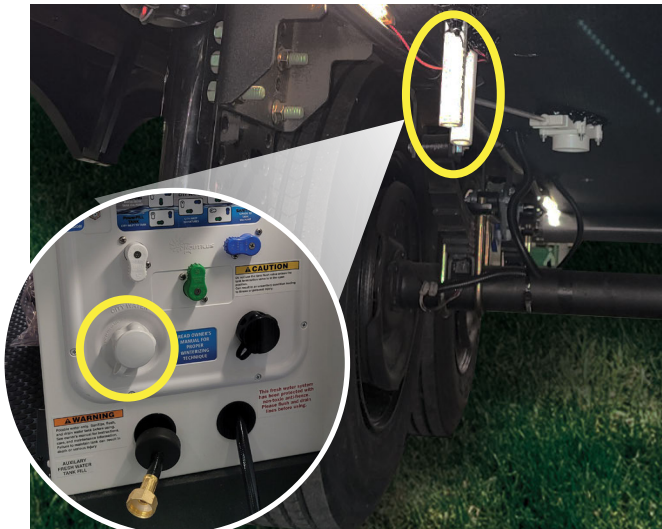

Under the RV, you will notice plastic overflow tubes that are directly plumbed into the freshwater tank. See picture, above. The purpose of these lines is to alleviate pressure as it is built within the tank, or to prevent the tank from being over-filled. On occasion, you may see water being expelled from these lines if the tank is overfilled, the RV is parked on an incline, or from stopping and starting while traveling. This is normal and should not pose a concern.

- **NEVER** block, cap, or modify the overflow tubes in any way.
- When the overflow tubes become obstructed, water pressure can build while filling and can cause damage to the plumbing system.

+ NOTICE

Freshwater supply should be disconnected when the RV is left unattended for extended periods of time. This will limit damage if there are leaks within the water system.

H. WATER HEATER—TANKLESS

1. General

Before using the hot water heater, please read all safety and operating instructions, information, and warnings provided within this manual and the manufacturer's manual. The tankless hot water heater installed within the RV is an on-demand water heater. The below shows the water heater outlined in red. As hot water is used, the tankless water heater will heat incoming cold water. This temperature is regulated by an internal sensor over a large heat exchanger. This design allows the hot water heater to operate with energy efficiency unlike most conventional tank water heaters that require constant energy during the re-heat cycles.



2. Controller Operation

Before operation perform a basic functional test of the RV and water system.

Refer to "Functional Test" of the component manufacturer's manual for instruction. After the Functional test is completed, the appliance can be operated from the wall controller which includes the Power switch. The wall controller is located in the bathroom cabinet and is shown in the picture (next page top left).





- a. Touch power button to turn the power **ON/OFF**. The Furrion logo on the panel will be illuminated and display the current temperature setting.

+ NOTICE

The microprocessor is always on. It draws approximately 0.25 amps, but it is advisable to turn off when not in use.

- b. Touch button marked “°F/°C” to change the temperature display from °F or °C

- c. Touch the  or  button to adjust the temperature to your desired settings between 95°F (35°C) to 124°F (51°C).

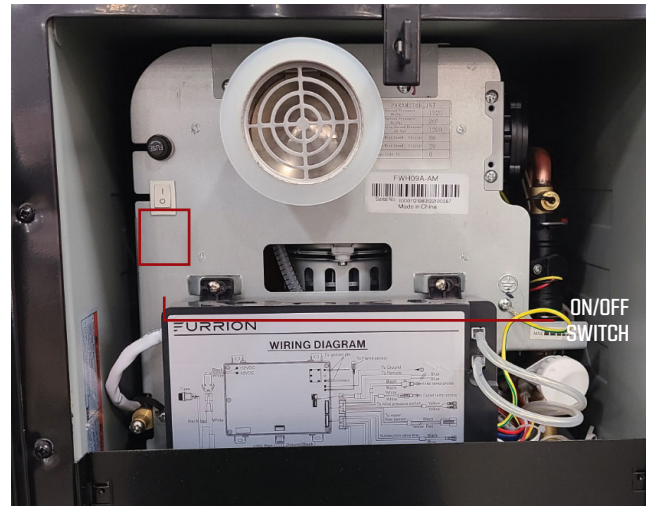

INSIDE THE EXTERIOR DOOR OF THE FURRION TANKLESS WATER HEATER

The temperature can be selected to operate in two different methods:

Method 1:

Point of use mixing: Set the controller temperature to a desired output temperature, typically elevated above comfortable bathing temperatures. i.e., 115°F (46°C). Turn **ON** the hot water. Once hot, add cold water to achieve desired temperature.

Method 2:

Single point use: Set the controller temperature to a desired output temperature for the faucet you want to use, typically set to the desired bathing temperature. i.e., 100°F. The unit will maintain the set temperature by use of the hot water faucet only, no need to mix cold water.

- d. Turn on the water faucet(s) and use as desired. The water temperature exiting the appliance (not faucet) will display.

SEC.13 PLUMBING SYSTEMS

3. Safe Operation

Consider the following points for safe use of the appliance:

- Install an RV water regulator to the inlet of the RV and operate between (45-80 PSI).
- The factory default water temperature setting is 115°F (46°C).
- There may be a variation between the temperature delivered from the appliance and the temperature at the faucet due to inlet water temperature or the distance from the appliance.
- Always check the water temperature, in reference to the chart below, by the display (step 3/4) and test before using to ensure the water is not too hot.

TEMP. °F (°C)	TIME BEFORE SKIN BECOMES SCALDED
155°F (68°C)	1 SECOND
148°F (68°C)	2 SECONDS
140°F (60°C)	5 SECONDS
133°F (56°C)	15 SECONDS
127°F (52°C)	1 MINUTE
124°F (51°C)	3 MINUTES
120°F (48°C)	5 MINUTES
100°F (37°C)	SAFE BATHING TEMPERATURE

Source: Moritz, A.R. / HERRIQUES, F.C.: Studies of thermal injuries: the relative importance of time and surface temperature in causation of cutaneous burns A. J. Pathhol 1947; 23: 695 - 720.

⚠ WARNING

SCALD HAZARD: Never allow infants or children to adjust the water temperature or be left unsupervised when using hot water. Tankless water heaters adjust quickly and may lead to serious injury if not properly used.

⚠ WARNING

Never store gasoline or other fuel sources near this appliance.

⚠ WARNING

The hot water heater must be operated in the manner intended and with the instruction provided by the manufacturer. Failure to follow these instructions may lead to serious injury, fire, or explosion, property damage or death.

4. Water Control Valve

The water heater is equipped with a water flow control valve, set from the factory at MAX flow.

The valve will reduce the water flow and capacity through the water heater to improve water heating performance. Under extreme conditions, it may be necessary to adjust the valve accordingly:

- Cold water inlet conditions approximately less than 45°F (7°C).
- Higher water inlet pressures >65 PSI. To operate, see below. (Fig. 30)

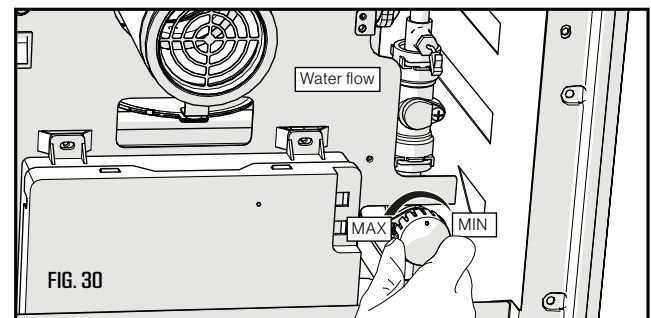

- **REDUCE** water flow: Rotate knob clockwise.
- **INCREASE** water flow: Rotate knob counterclockwise.

5. High Altitude Use

This appliance can be used at high altitude and has been tested up to 4500ft.

For prolonged use at higher altitudes please contact support@furrion.com.

6. Storage and Transit

Anytime the RV is not intended to be used, it is considered to be in storage or transit. To prepare the water heater, follow the below steps:

- a. Turn off gas supply.
- b. Turn off water heater main switch.
- c. Drain water out of the system and water heater by removing the filter cover and drain plug, see below. **(Fig. 31)**

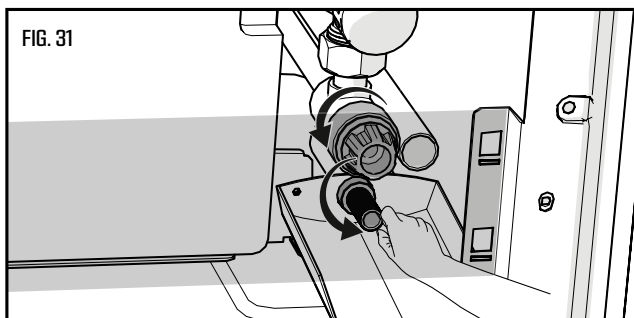

- d. If freezing conditions could occur, then winterize according to "Winterizing Water Heater."

7. Routine Inspection

Routine inspection is critical for maintaining proper operation of your appliance. Unless specified, review the following items annually or before each season:

- a. Inspect the gas system and appliance immediately upon purchase, after the first LP fill, after the first 5,000 miles traveled, and on a continuous basis.
- b. Inspect for cracks, separation, peeling of seals to the RV wall. Remove and re-seal as necessary (caulking or tape) between the side wall and the door of the water heater and ensure that the unit is solidly mounted to the vehicle.
- c. Verify that the air inlet openings (louvers) are completely open and clear of any debris including mud, leaves, twigs, insects, etc. Remove all obstructions to allow full air flow.
- d. Insects, including wasps and spiders, can build nests in the exhaust tube outlet which will affect the performance of the unit. Inspect the flue outlet tube to make sure that it is unobstructed and that the screen is clean. If debris or insects are present, clean, and vacuum to remove any remaining debris. The use of any type of after-market screen to cover the vent is not permitted and will void the warranty.
- e. Open the door and verify that no debris or extraneous combustible materials are present anywhere (especially in the burner and the gas controls). Remove any item present and wipe clean the bottom of the housing.
- f. Inspect the interior surface of the housing for any cracks or corroded areas that could allow penetration of gases into or out of the interior of the vehicle. Check especially around the hot water, cold water, gas and electrical connections.

+ NOTICE

If damage is found, please contact a technician to repair or contact Furrion Customer Service.

SEC.13 PLUMBING SYSTEMS

- g. Check that all wire connections are firmly in place and there are no signs of chafing or cracks on the insulation. Verify that the spark ignition cable between the Control Board and the igniter is securely in place and not shorted to any metal component.
- h. Inspect the pressure safety valve to ensure it has not been leaking (no water residue). See “Pressure Safety Valve Maintenance” for further inspection. **(Fig. 32)**
- i. Inspect/clean/replace water inlet filter as necessary, see “Filter Cleaning” section.
- j. Turn on the power to the water heater and open a hot water faucet to inspect the flame of the burner. The flame should be of the normal bluish appearance that indicates proper combustion. This can be accomplished by removing the water heater door and baffle to observe the flames by looking at the burner under the edge of the heat exchanger **(Fig. 33)**
- k. A sealing ring is assembled on the chimney. **(Fig. 34)** Inspect to make sure the seal does not have any cracks or breaks, and that it is in good condition. Contact Furrion for replacement.

+ NOTICE

When installing the seal, make sure the words “INSIDE” are facing inward.

⚠ WARNING

BURN OR SCALD HAZARD:

- **NEVER** drain the hot water heater while hot.
- **NEVER** perform work on the water heater while it is operating.
- **NEVER** perform work unless the Electrical and LP gas supply is shut off.
- **NEVER** perform work while the appliance is hot.
- **NEVER** actuate the pressure relief valve if the appliance is still hot.
- **Never** actuate the drain plug if the appliance is under water pressure and/or is still hot.

8. Filter Cleaning

There is a filter screen on the Water Heater inlet water line connection. The filter screen needs to be cleaned periodically to prevent blockages from forming. Follow below steps below to clean the filter: **(Fig. 35)**

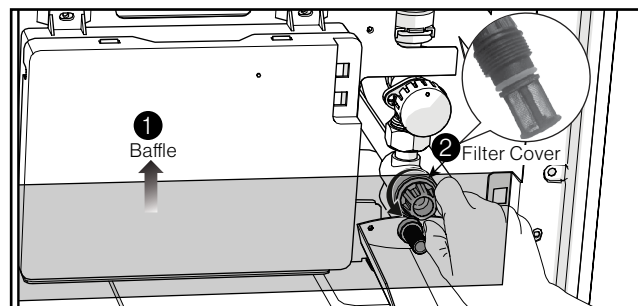

FIG. 35

- a. Open the door of the water heater and remove the baffle.
- b. Unscrew the filter cover by hand or with a proper tool counterclockwise.
- c. Clean the screen filter by flushing any debris accumulated.

9. Pressure Safety Valve Maintenance

- The unit is equipped with a water pressure safety valve. The pressure safety valve needs to operate once each year to ensure this safety device is effective.
- The pressure relief valve is a safety component and must not be removed for any reason other than replacement.

+ NOTICE

The pressure relief valve must be replaced by a certified service technician if defective.

- Tampering with the pressure relief valve will void the warranty.
- On the back of the water heater:
 - ROTATE** the pressure safety valve handle (Red) about 3~5 times counterclockwise. (Fig. 36)

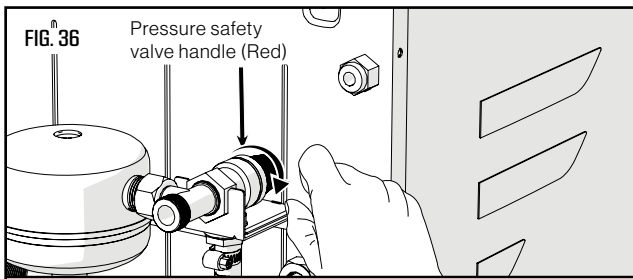

- Check the drain hose for water. (Fig. 37)
Water in the drain hose indicates the pressure safety valve is working properly.

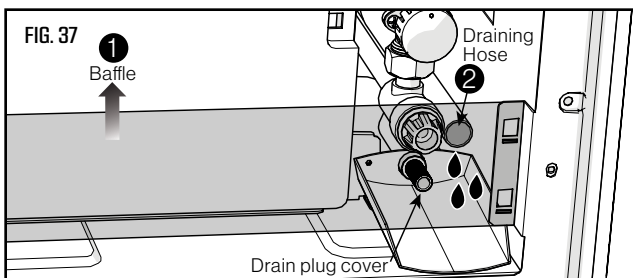

+ NOTICE

Never actuate the drain plug if the appliance is still hot.

+ NOTICE

Hard Water and Decalcification: For prolonged usage, when exposed to higher water hardness concentrations, it is advised to provide a proper water treatment device for the incoming water to the RV. Hard water may lead to Performance reduction of your appliance over time. Contact Furrion for decalcification instructions.

I. BATHROOM SHOWER

1. General

Unlike a household, the RV does not contain a water pressure balance valve. Refrain from running other water sources while the shower is in use. Air may need to be purged from the lines before a steady stream can flow.

- Always be aware of the holding tank capacities. Water that is used will drain directly into the gray holding tank and can back up when full.
- Turn the water heater **ON** and allow the coils to properly heat.
- If dry camping, the water pump will need to be turned **ON**.
- Adjust the hot and cold temperatures with the faucet knob. Make sure the desired temperature is achieved **BEFORE** entering the shower.
- To conserve water, wet down and turn **OFF** the water supply while washing. Then, turn **ON** to rinse.
- When finished, shut **OFF** the knobs to the hot and cold water.

SEC.13 PLUMBING SYSTEMS

+ NOTICE

There is no shut-off valve at the shower head. Water must be shut OFF using the knobs on the faucet. Once water is shut OFF, water may slightly drip from the shower head. This is normal and is NOT an indication of a leak.

2. Maintenance

The shower walls within the RV are made of fiberglass and should be cleaned with a mild dish soap and water solution only. **DO NOT** use abrasive or harsh chemicals, compounds, or soaps when cleaning the shower.

3. Shower Door

Your RV is equipped with a glass shower door. The door has three (3) individual panes of glass that make up the door. These 3 panes of glass slide left and right in the shower door extrusions to permit ingress and egress into the shower. It is important to ensure that the travel latch on the shower door is properly latched prior to travel. Depending on the bathroom layout, the latch could be located on the interior or exterior of the door. In the picture provided to the right, the travel latch is located on the interior of the shower door.



To unlatch the door:

1. Slide the thumb latch to the left
2. Then, rotate the latch upward to release the door from its travel latched position.



To latch the door for travel:

1. Slide all three glass panels to the travel latch door jamb side.
2. Slide the thumb latch to the left.
3. Rotate the travel latch down so that it re-engages on the knob that is fastened to the glass.
4. Release the thumb latch. Test to ensure the door is properly latched by lifting up on the hook portion of the latch. It should be locked at this point and you should not be able to lift the hook off of the post.

⚠ CAUTION

It is very important that you properly stow the shower door for travel as indicated by the above-provided instructions. Failure to latch the shower door in its travel position will likely lead to the shower door glass shattering in transit. This is a common occurrence as people tend to forget this step before towing the RV. A shower door with shattered glass is not covered by either the Brinkley RV or the shower door manufacturer's warranties.

J. FAUCETS

The faucets installed within the RV operate much like those in your home.

- Make sure there is a sufficient water supply.
- Turn **ON** the water pump if dry camping.
- Turn **ON** the water supply at the faucet and adjust temperature.
- Turn off when finished.

K. EXTERIOR SPRAY PORTS

There are two (2) exterior spray ports located in the RV. The first is in the convenience center in the pass-through storage compartment on the off-door or driver side of the RV (picture on the below right). The second is located on the wall of the pass-through storage on the door or passenger side of the unit (picture below left). These spray ports are provided for external washing and rinsing.



OPERATING THE SPRAY PORTS:

1. **ATTACH** the supplied quick-connect hose and sprayer to the spray port. The quick-connect hose and spray are shown in the picture of the convenience center above.
2. Turn the water heater **ON** and allow sufficient time to heat.
3. When dry camping, turn **ON** the water pump.
4. Turn **ON** the hot and cold water using the knobs and adjust the temperature accordingly.

WHEN FINISHED:

1. Turn **OFF** the hot and cold water using the knobs.
2. **DISCONNECT** the quick-connect sprayer and allow excess water to drain.

SEC.13 PLUMBING SYSTEMS

L. UNIVERSAL DOCKING CONVENIENCE CENTER—THE NAUTILUS P4-3 PANEL

1. General

Your Brinkley RV is equipped with a Universal Docking Convenience Center (referred to as “convenience center” throughout this manual). It is called the Nautilus P4-3 Handle system. The instructions on how to utilize the convenience center is covered in detail in the paragraphs that follow.



+ NOTICE

IMPORTANT – NEVER push the check valve on the “CITY WATER” connection with pressure in line. This will cause irreparable damage to the check valve function. See the picture below for location of the check valve on the city water connection.



THE NAUTILUS P4 PANEL SYSTEM WILL ALLOW YOU TO PERFORM THE FOLLOWING FUNCTIONS:

1. Power fill your fresh water tank for remote or dry camping.
2. Use your water pump to supply water to fixtures from the freshwater tank.
3. Use your water pump to siphon fill or sanitize your freshwater tank from a bucket.
4. Connect to city water at the camping site to supply water to the fixtures.
5. Winterize your plumbing lines and fixtures.
6. Rinse the black tank to help control odors and prevent sewage buildup.
7. Rinse off items outside the unit with a hot or cold faucet.
8. Connect coax lines with satellite, cable, and auxiliary.

2. Handle Position and Valve Routing Information

WHITE HANDLE:

Receives water from water inlet on front of panel.

Sideways—water goes to pump inlet.



Down—water goes into blue handle.



BLUE HANDLE:

Receives water from the white handle valve/water inlet on front of panel.

Sideways—water goes to fixtures (cold).

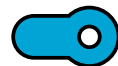

Down—water will go to or come from fresh water tank.



GREEN HANDLE:

Is an on/off through valve that feeds pump from fresh water tank.

Sideways—water will not flow through valve.



Up—water will go to or come from fresh water tank.



4. Turn water supply on at source.
Fresh water tank should begin to fill.

+ NOTICE

Consult your Owner's Manual for tank capacity. Do not overfill tank.

3. Fresh Water Tank PowerFILL

1. Connect garden hose to inlet labeled "**CITY WATER**".
2. Turn handles to "**PowerFILL Tank**" position as shown.
 - **BLUE** diverter handle should be facing down.
 - **WHITE** diverter handle should be facing down.
 - **GREEN** diverter handle should be facing down.

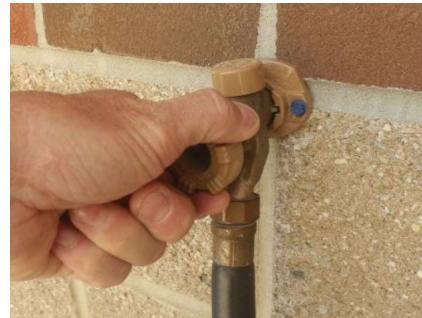

5. When desired level in fresh water tank is reached, turn water off at source.
6. Disconnect garden hose from inlet on Nautilus panel.

3. Connect other end of hose to water supply source.

SEC.13 PLUMBING SYSTEMS

4. Sanitizing the Fresh Water Tank

1. Connect garden hose to inlet labeled "CITY WATER".
2. Turn handles to "SIPHON" position as shown.
 - **BLUE** diverter handle should be facing down.
 - **WHITE** diverter handle should be facing right.
 - **GREEN** diverter handle should be facing left.



3. Place other end of hose in container holding water or sanitizing solution.



4. Push "PUMP" switch to turn on pump.



+ NOTICE

LED indicator light below the pump switch will be lit if pump has power.

5. Pump should be running and fresh water tank should begin to fill.

+ NOTICE

Consult your Owner's Manual for tank capacity. **DO NOT OVERFILL TANK.**

6. When desired level in fresh water tank is reached, press "PUMP" switch to turn pump off.

+ NOTICE

LED indicator light below the pump switch will not be lit.



7. Disconnect garden hose from inlet on Nautilus panel.

5. Fresh Tank Supply—“Dry Camping”

1. Make sure fresh water tank has necessary supply of water.
2. Turn handles to **"DRY CAMPING"** position as shown.
 - **BLUE** diverter handle should be facing left.
 - **WHITE** diverter handle should be facing down.
 - **GREEN** diverter handle should be facing up.



3. Press **"PUMP"** switch to turn pump on.

+ NOTICE

LED indicator light below the pump switch will be lit if pump has power.

4. Water should be available to all fixtures.

+ NOTICE

The pump will run when a plumbing fixture is open.

5. Make sure pump is turned off when not in use.

6. Utilizing a Pressurized Water Source—“City Water”

1. Connect garden hose to inlet **"CITY WATER"**
2. Turn handles to **"CITY WATER"** position.
 - **BLUE** diverter handle should be facing left.
 - **WHITE** diverter handle should be facing down.
 - **GREEN** diverter handle should be facing left.



11. **OPEN** all interior faucets and turn **ON** the interior shower(s). You should complete these steps at each faucet one at a time. At each location:

SEC.13 PLUMBING SYSTEMS

3. Connect other end of hose to water supply.



4. Open faucet at water supply source.
Water should be available to all fixtures.

2. Open black waste holding tank and leave open to allow black tank to drain.

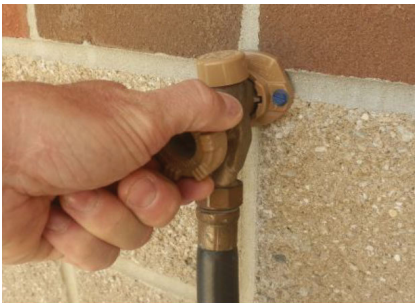
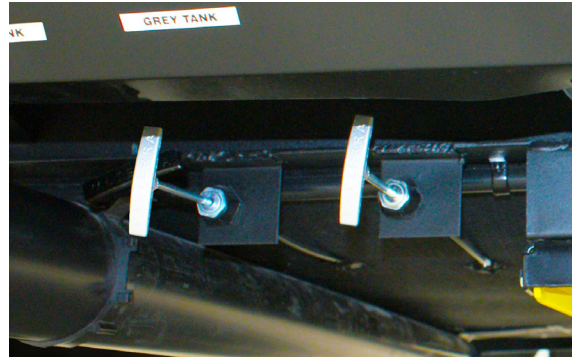

Over pressurizing water lines may cause damage to plumbing lines and fixtures.

7. Rinsing the Waste Tank—"Tank Flush"

1. Connect flexible sewer hose to 4" dump outlet on unit.



3. Attach a garden hose to inlet labeled "TANK FLUSH".



+ NOTICE
Handle throw does not matter.

4. Connect other end of hose to water supply source.



5. Fully open faucet at water supply source (40 psi minimum). Flush tank until water appears clear in 4" discharge hose.

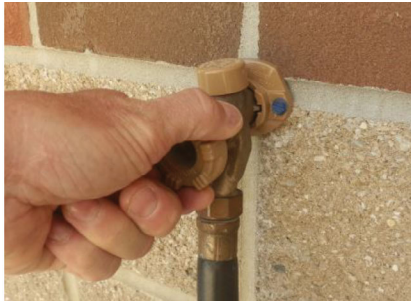

6. Completely close faucet at water supply source.
7. Disconnect garden hose from water source.
8. Disconnect garden hose from "**TANK FLUSH**" inlet.
9. **Close black waste holding tank valve.**

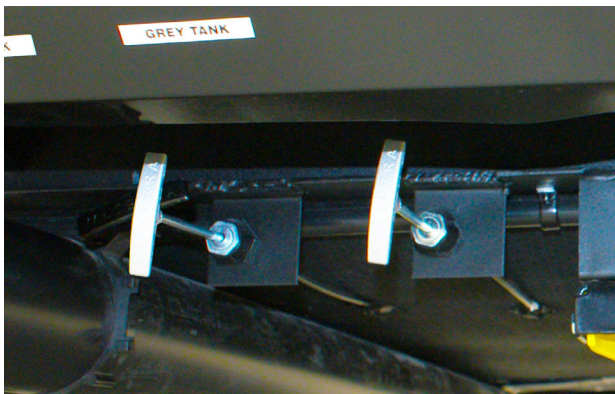

+ NOTICE

To help ensure debris does not clog tank sprayer orifices, use "TANK FLUSH" every time waste holding tank is emptied.

+ NOTICE

The images provided pertaining to the convenience center panel are provided for illustrative purposes only. They do not necessarily reflect the way that your Brinkley RV is equipped. By way of example, the termination valve handles shown in the pictures does not exist on your Brinkley RV as we provide electric termination valves.

SEC.13 PLUMBING SYSTEMS

8. Integrated Fresh Water Retractable Hose Reel

Your RV is equipped with an integrated fresh water retractable hose reel. The hose reel is mounted behind the convenience center and is located on a drainage pan that permits any water to run out through the bottom of the RV. Each end of the hose reel protrudes out of the front of the convenience center panel as shown to the right. The total length of the hose is 65 feet. You should have 55-60 feet of available hose to utilize. The hose end on the left in the convenience center is the end that can be extended and retracted. Simply pull on the hose to extend. To retract, lightly tug on the hose and keep any tension off of the hose as it retracts.

The hose end on the right in the convenience center is used to connect to either the **CITY FILL** or the **TANK FLUSH** connections.



M. DRAINING THE FRESH WATER SYSTEM

Before storing the RV throughout winter months, the water system should be drained and winterized. This should be completed for all components of the water system including the hot and cold-water lines, water heater, faucets, and P-traps. Under your RV, you will notice red and blue water lines with shut OFF valves. These release the water within the supply lines and are referred to as the low point drains. To drain all water from the supply lines and fresh tank, follow the below instructions.

DRAINING THE FRESH WATER SYSTEM:

1. **OPEN** all faucets, including the outside shower (If Equipped) and external spray down ports.
2. **OPEN** the Fresh Water Holding Gate Valve. This valve is a white T-handle valve that is located under the RV and close to the axle. See photo, upper right.
3. **OPEN** both low point drains. See photo, lower right.
4. **DRAIN** all sinks.
5. Remove the water heater drain plug. See [Section 13H\(6\)](#).
6. Turn **ON** the water pump to ensure all water is pushed through.
7. **After draining the Fresh Water System, REVERSE these steps to ensure the system is closed.** It is common for a small amount of water to remain in the system.

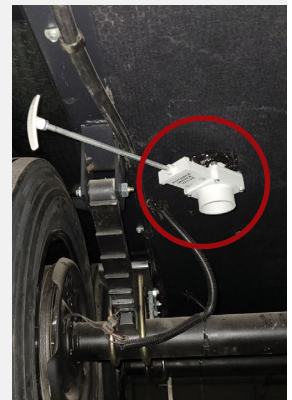

N. SANITIZING THE FRESH WATER SYSTEM

The Fresh Water System should be sanitized after purchase of the RV, anytime contamination may have occurred, and after extended periods of no use. Please follow the below instructions to sanitize the Fresh Water System.

- Mix one (1) gallon (3.785 liters) water with a ¼ cup (59.147 ml) of household bleach (5% sodium hypochlorite solution).
- You will need approximately one (1) gallon (3.785 liters) of solution for every fifteen (15) gallons (56.78 liters) of tank capacity.

+ NOTICE

If you choose to by an aftermarket solution, please refer to the supplied instructions and follow as directed.

SANITIZING THE FRESHWATER TANK AND SYSTEM:

1. **ENSURE** the RV is level.
2. **EMPTY** the fresh tank by opening the fresh water holding gate valve.
3. **CLOSE** the fresh water holding gate valve. See picture, upper right.
4. **ENSURE** the low point drains are closed. See picture, middle right.
5. **CONNECT** a garden hose to the City Water port and the other end into the sanitizing solution. **DO NOT** use your portable freshwater hose. See picture, lower right.

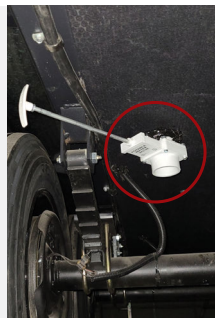

6. Turn **ON** the water pump and run it until the solution is empty.
7. **PROCEED** by filling the freshwater holding tank.
8. **PURGE** all waterlines by turning on the faucets. You must purge both the hot and cold lines of each faucet. Once completed, turn **OFF** the water pump.
9. **ALLOW** the sanitization solution to stand for at least three (3) hours.
10. **DRAIN** and **FLUSH** the Fresh Water System with fresh water.
11. To remove excess chlorine odor, mix one (1) quart (0.946 liter) vinegar to five (5) gallons (18.927 liters) water and repeat steps 3-9 above.

O. WINTERIZING THE PLUMBING SYSTEM

Preparing for storage is a vital for the protection of your RV. Anytime temperatures are likely to drop near or below 32°F (0°C), the RV should be winterized. This is to prevent the waterlines, tanks, and the water heater from freezing and becoming damaged. The plumbing system should only be winterized with RV antifreeze and no other solutions.

+ NOTICE

Always clean RV antifreeze from all surfaces to prevent staining in the sinks, tub, or toilet.

⚠ WARNING

NEVER use automotive antifreeze or windshield washer anti-freeze as they are poisonous. They are harmful when consumed and may be fatal if swallowed.

SEC.13 PLUMBING SYSTEMS

+ NOTICE

Winterizing the RV may be more efficient and easier if another person is able to assist you. Please contact your Dealer for assistance if needed.

BEFORE YOU START:

Here are the items that you will need:

1. 3 gallons (11.36 liters) of non-toxic RV/Marine anti-freeze (Customer Supplied).



2. Air compressor with pressure regulator capable of producing 30-40 PSI (206.8-275.8 kPa) of pressure.

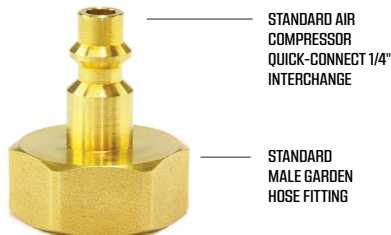

3. Standard Air Compressor Quick Connect Fitting. Picture shown below (Customer Supplied).
4. A short length of garden hose that has a male fitting on one end.
5. A full-length garden hose to flush the black and gray tanks. Note, it is preferred to use the retractable hose reel integrated into the convenience center panel. See [Section 14L\(8\)](#).

+ NOTICE

The black and gray tanks should already be emptied of wastewater before commencing the winterization process.

FOLLOW THESE STEPS TO WINTERIZE:

1. **LEVEL** the RV. See [Section 6J](#).
2. **CONNECT** the provided hose from the retractable hose reel (See [Section 13L\(8\)](#)) or a full-length garden hose to the tank flush inlet and to a water supply source (i.e., an outside water spicket). See picture below for the hose attachment location.



3. **FLUSH** the black holding tank(s) utilizing the tank flush line. See [Section 13L\(8\)](#) for instructions on how to flush the black tank(s).
4. **DRAIN** all black, gray, and freshwater holding tanks.
 - a. See [Section 13S\(3\)](#) for instructions on how to empty the black and gray holding tanks.
 - b. See [Section 13M](#) for instructions on how to drain the freshwater tank(s).

- CLOSE** the black, gray, and freshwater valves after they have all drained.
- SET** the convenience center panel to **POWERFILL** by setting the valves on the convenience center as indicated in the picture below. The blue and white valves should be pointed downward. The green valve should point left.



- Turn **OFF** the water pump. You can turn the water pump off at the Convenience Center (picture below left) or the Control Panel (picture below right).



OR

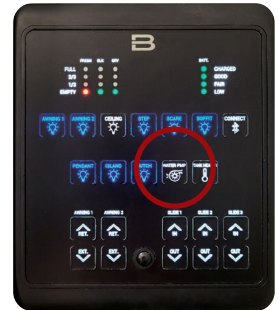

- Turn **OFF** the water heater (see [Section 13H](#)) from the water heater controller in the bathroom cabinet and remove the drain plug. Allow all the water to drain. You must remove the cover of the water heater located on the outside of the unit. The picture below on the left shows the location of the drain plug. The picture below on the right shows the location of the water heater on the exterior of the unit on the off-door side.

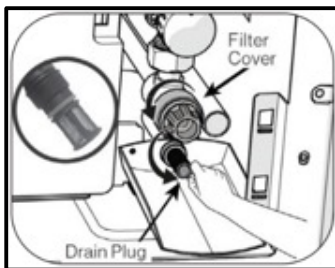

- OPEN** the low point drains. They are located underneath the RV on the off-door side of the RV and protrude through the underbelly. Allow all water to drain.



- FLUSH** the toilet to remove all water from the toilet bowl. You will need to keep the toilet flush foot pedal depressed on the toilet until all water is drained from the toilet.

SEC.13 PLUMBING SYSTEMS

- a. Start by opening the hot water valve.
 - a. Leave the valve open until all water is drained. Then close the hot water valve.
 - b. Then, open the cold-water valve.
Leave the valve open until all water is drained. Then close the cold-water valve.
 - c. **NOTE:** If the faucet does not have separate hot and cold-water valves, you must first open the valve with the handle set all the way to hot. Then move the handle all the way to cold.
12. **CONNECT** using the supplied quick connect hose (see picture in 'c' below) to the exterior faucets (one at a time).
- a. Start by opening the hot water valve.
Leave the valve open until all water is drained. Then close the hot water valve.
 - b. Then, open the cold-water valve.
Leave the valve open until all water is drained. Then close the cold-water valve.
 - c. Repeat at the other exterior faucet location. The two locations are shown in the photos immediately below:



13. **SET** the Convenience Center Panel valves as indicated in the picture at the top right:



14. Using the **CITY WATER INLET** (located at the red circle shown in the picture above) on the convenience center panel:
- a. **ATTACH** the air compressor quick connect fitting to the city water inlet;
 - b. **ATTACH** the air compressor hose to the quick connect fitting;
 - c. **SET** the air compressor regulator to 30-40 PSI (206.8-275.8kPa).
 - d. **TURN** the air compressor on.
15. **CLOSE** the low point drains after allowing all water to drain.
16. **REPLACE** the drain plug in the water heater after allowing all water to drain.
17. **REPEAT** steps 10, 11 and 12 above while the air compressor is still attached and on.
18. **TURN OFF** the air compressor and disconnect the air hose and fitting from the **CITY WATER** inlet on the convenience center.

19. **SET** the valve handles on the convenience center panel to **WINTERIZE** as shown in the photo below:



20. **CONNECT** a short section of garden hose to the inlet labeled “**CITY WATER**” on the convenience center panel and as shown in the picture immediately above.
21. **PLACE** the other end of the garden hose into the RV antifreeze jug.
22. **TURN ON** the water pump. See **step 8** above for the water pump switch locations.
23. The pump should be running, and the RV antifreeze should begin to flow through the pump into the plumbing lines and fixtures.
24. **REPEAT** steps 10, 11 and 12 until antifreeze is present at each location. You should permit RV antifreeze to flow from each fixture. You must perform this at each location one at a time.
25. **TURN OFF** the water pump once antifreeze is present at all fixtures.

26. **DISCONNECT** the garden hose from the convenience center panel.

27. **POUR** RV 1/2 cup (118.3 ml) of RV antifreeze down each sink drain and 1 cup (236.6 ml) of RV antifreeze down toilet drain.

28. **COMPLETE!** Your plumbing system is now prepped for winter storage.

P. DE-WINTERIZING THE PLUMBING SYSTEM

BEFORE YOU START—

You will need the following items before you start the winterization process:

1. A 5-gallon (18.927 liter) bucket.
2. Household bleach.
3. 8 to 12 ounces (236.6 -354.9 ml) of fresh water in a small bottle.
4. A liquid measuring cup.
5. A garden hose

The Fresh Water System should be sanitized after purchase of the RV, anytime contamination may have occurred, and after winterization or extended periods of no use. Please follow the below instructions to sanitize the freshwater system:

- Mix one (1) gallon (3.785 liters) water with a ¼ cup (59.147 ml) of household bleach (5% sodium hypochlorite solution).
- You will need approximately one (1) gallon (3.785 liters) of solution for every fifteen (15) gallons (56.78 liters) of freshwater holding tank capacity. You should place this mixture in the 5-gallon bucket.

Please consult your Dealer if you have questions regarding the size of your fresh water holding tank or contact Brinkley RV Customer Care.

SEC.13 PLUMBING SYSTEMS

To De-Winterize, follow the following steps:

1. Ensure the RV is level (See [Section 6J](#)).
2. **ENSURE** the low point drain is closed. They are located underneath the RV on the off-door side of the RV and protrude through the underbelly. See the picture below for an example of the low point drains.

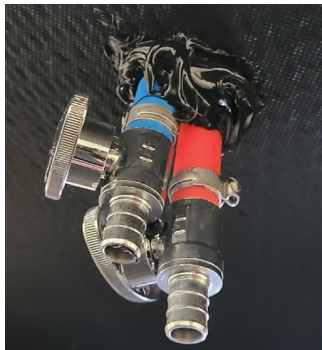

3. **CONNECT** a garden hose to the **CITY WATER** port on the convenience center. See picture, right. Place the other end of the garden hose in the 5-gallon (18.927 liters) bucket that contains your sanitizing solution.
4. **SET** the convenience center valves to **SIPHON** (white valve pointing right, blue valve pointing down, green valve pointing left). See picture, below.



5. **TURN ON** the water pump and fill the fresh tank with the full amount of sanitizing solution. You can turn the water pump on at the convenience center (picture below left) or the control panel (picture below right):



OR



6. **FLUSH** the toilet and keep the foot pedal depressed on the toilet until all the RV antifreeze is purged from the toilet and the sanitizing solution is flowing into the toilet bowl.
7. **ADD** 8-12 ounces (236.6-354.9 ml) of fresh water into the toilet bowl to dilute the sanitizing solution at the toilet seal.
8. **OPEN** all interior faucets and turn **ON** the interior shower(s). You should complete these steps at each faucet one at a time. At each location:
 - a. Start by opening the hot water valve. Leave the valve open until all the RV antifreeze is purged and the sanitizing solution is present and flowing from the faucet. Then close the hot water valve.
 - b. Then, open the cold-water valve. Leave the valve open until all the RV antifreeze is purged and the sanitizing solution is present and flowing from the faucet. Then close the cold-water valve.

+ NOTICE

If the faucet does not have separate hot and cold-water valves, you must first open the valve with the handle set all the way to hot. Then move the handle all the way to cold.

9. **CONNECT** using the supplied quick connect hose to the exterior faucets (one at a time).
- Start by opening the hot water valve. Leave the valve open until all the RV antifreeze is purged and the sanitizing solution is present and flowing from the faucet. Then close the hot water valve.
 - Then, open the cold-water valve. Leave the valve open until all the RV antifreeze is purged and the sanitizing solution is present and flowing from the faucet. Then close the cold-water valve.
 - Repeat at the other exterior faucet location. The two locations are shown in the photos immediately below:

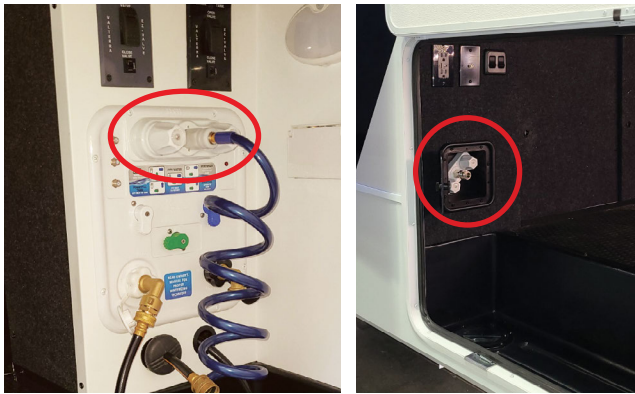

10. **ALLOW** the sanitation solution to stand in the water lines for at least three (3) hours.
11. **DRAIN** all black, gray, and freshwater holding tanks.
- See [Section 13S\(3\)](#) for instructions on how to empty the black and gray holding tanks.
 - See [Section 13M](#) for instructions on how to drain the freshwater tank(s).
12. **FILL** the freshwater holding tank with fresh water only. Repeat step 7 through 11 above to purge the system of the sanitizing solution. Note that each fixture should be run for approximately 20 seconds each to flush the lines of the sanitizing solution.

13. **REPEAT** step 12 in its entirety a second time to ensure the sanitizing solution is completely removed from the plumbing system.

14. **COMPLETE!** You are now ready to go RV'ing!

Q. BLACK WATER AND GRAY WATER SYSTEMS

The toilet in the RV drains to the black water holding tank. The shower and sinks within the RV drain to the gray water holding tank.

- Before towing the RV, the gray and black holding tanks should be emptied to avoid carrying unnecessary weight.
- If you are unable to empty the tanks while dry camping, reduce your towing speed until these tanks can be emptied at the next dump station.

+ NOTICE

The cargo carrying capacity of the RV is based on ALL holding tanks being empty. If the tanks are full, this weight must be deducted from the cargo carrying capacity.

⚠ WARNING

Traveling with full holding tank(s) may result in:

- Limiting available cargo carrying capacity
- Exceeding the GAWR or GVWR
- Damage to suspension components i.e., as springs, tires, and axles)
- Fluctuating hitch weight, depending on the location of the holding tanks and which tanks are filled
- Unwanted towing characteristics such as trailer sway and other handling difficulty.

SEC.13 PLUMBING SYSTEMS

R. TOILET

1. General

The toilet in the RV uses roughly three (3) quarts (2.839 liters) of water per flush. This amount is about ten times less than that of a residential toilet. When flushing solids, additional water may be needed to fully remove waste from the lines.

+ NOTICE

When flushing, **ALWAYS** continue to run water for an extra 10-15 seconds after flushing. If enough water is not used, pipes and tanks may become clogged.

⚠ WARNING

NEVER use automotive antifreeze, windshield washer anti-freeze, laundry detergents, or other caustic chemicals as they are poisonous. Although these products may have deodorizing capabilities, they are damaging to the components within the plumbing system and are toxic if ingested.

2. Preventing Toilet Blockage

- Before using the toilet, ensure there is sufficient water in the toilet, approximately 4-6 inches (10.16-15.24 cm). This can be accomplished by flushing the toilet several times until water is present.
- Use RV grade, single-ply toilet paper.
- Never flush baby wipes, disposable wipes, or any other foreign objects down the RV toilet (i.e., hygiene products, feminine products, cleaning wipes, paper towels, diapers).

3. Cleaning and Maintenance

- Clean the toilet on a regular basis.
- Use tank treatments to clean the black tank when needed.

- Applying petroleum jelly when needed to the toilet ball valve to provide waterproof lubrication without damaging other seals.

+ NOTICE

Never use chlorine or other abrasive solutions in the RV toilet (i.e., laundry bleach, chemical drain openers). These products will **DAMAGE** the seals in the toilet and dump valves.

+ NOTICE

It is vital to prevent solid buildup in the drain lines and black tank. Follow the toilet manufacturer's manual for instructions and maintenance information.

S. BLACK AND GRAY WATER HOLDING TANKS

1. Black Water Tank Preparation

To help break down solid contents within the tank and to minimize odors, a deodorizer treatment (Customer Supplied) should be used. Please see the following instructions.

AFTER DUMPING THE HOLDING TANKS, AND BEFORE THE FIRST USE:

1. **RELEASE** roughly one to two quarts (1-2 liters) of water into the toilet bowl.
2. **ADD** the suggested amount of tank deodorizer (Customer Supplied) by inserting the content into the toilet.
3. **FLUSH** the toilet and allow an additional two (2) gallons (7.571 liters) of water flow into the holding tank.

2. Gray Water Tank Preparation

No preparation is needed for the gray tank. To help control odors, add a small amount of baking soda or RV tank deodorizer down the drains as needed.

3. Emptying Black and Gray Water Tanks

At the top of the convenient center, you will find the black and gray tank drain valve switches, also referred to as dump valve switches. When dumping the black and gray tanks, it is important to dump the black holding tank first, then the gray tank. This will help to remove any solids left behind from dumping the black tank.

EMPTYING BLACK AND GRAY TANKS:

1. Generally, accumulated solid waste will loosen within the black holding tanks as the RV is transported to a disposal location.
2. Always level the RV before dumping to make the process more efficient. See [Section 6J](#).
3. **LOCATE** the Sewer Outlet on the off-door side. See picture, top right in subsection (4) page 144.
 - a. **REMOVE** the housing cap on the outlet.
 - b. **ATTACH** a sewer hose to the outlet (Customer Supplied).
4. **PLACE** the opposing end of the sewer hose in the designated dump location.
5. **OPEN** the Black Tank Dump Valve by pulling the T-handle below the lower wrap on the off door side of your unit.

6. **CLOSE** the tank valve by pressing the T-handle in to the **CLOSE** position. .
7. **EMPTY** the gray tanks by pulling the T-handle for the gray dump valve located below the lower wrap on the off door side of your unit. .
8. **REMOVE** the sewer hose once all tanks are emptied, clean them, and store for the next use.
9. **ENSURE** the housing on the sewer outlet is reinstalled.

When Connected at the Campground Sewer Drain:

Keep the dump valve switches closed until the tanks are $\frac{3}{4}$ full to prevent solids from building in the drain lines. Never keep the black dump valve switch open.

4. Gray and Black Tank Pull Handles, Sewer Outlet, and Sewer Hose Storage Tube

The picture below shows the black and gray tank valve pull handles. They are located on the off-door side at the rear of the trailer.



SEC.13 PLUMBING SYSTEMS

The picture below shows the sewer outlet on the off-door side of the RV. The sewer outlet cap on your RV is clear so that you can make sure there is not wastewater behind the cap prior to taking the cap off.



The picture below shows the sewer hose storage tube. The tube is capable of storing two sections of hose. The valve ends of the hose have to be removed prior to storage.



5. Dump Station Locations

Dump station can be found on many websites, campground ground offices, and publications including Good Sam Camp Guide, KOA campgrounds Camp Guide, Woodall's Campground Magazine, Rand McNally Camp Guide, etc. Dump stations can also sometimes be found at local gas stations.

The sewer hose and its components are the Customers responsibility to purchase. If you happen to need assistance, please contact your Dealer.

6. Vents and Vent Pipes

It is vital to keep all exterior plumbing vents clear and free of any possible obstructions. If these vents become clogged or obstructed, the tanks will not be able to properly drain. Inspect these vents on a continuous basis and clean as needed.

7. Drainpipes With Dry Sealing Valve

A dry, waterless P-trap is used on the drain system of the RV. This form of P-trap will help to prevent odors from escaping the waste system and will eliminate the need of a traditional P-trap. In the circumstance the drain becomes clogged with this installation, a mechanical clean-out tool will need to be used to clear the obstruction.

+ NOTICE

The dry waterless P-trap **MUST** be removed before using a mechanical clean-out tool. If the dry valve is not removed, the seal will become damaged and will not operate as designed.

9. Black Tank Flusher

Your RV is equipped with a black tank flusher. This feature is designed to rinse the interior portion of the black tank through a separate water connection port. To prevent water from backflowing, there is a flush valve installed in-line. See [Section 13L\(8\)](#), Docking Station User Instructions.



FLUSHING THE TANK AFTER DUMPING:

1. After draining the tanks, leave the sewer hose connected to the drain outlet and the dump location.
2. Connect the external water source to the black tank flusher inlet. Use a garden hose **NEVER** your freshwater hose.
3. Open the black tank valve.
4. Turn on the water source fully to flush the tank
5. When the drainage begins to run clear from the sewer hose, turn off the water source and disconnect it from the RV.
6. Disconnect the sewer hose **AFTER** all water is drained from the system.

⚠ WARNING

When the tank is being flushed, the black tank gate valve must be open. Failure to open the valve will result in damage to the system and may lead to unsanitary conditions that may further result in illness or personal injury.

+ NOTICE

DO NOT add any check valves to this system or leave any hose connected when not in use.

SEC.14 FURNITURE

A. DINETTE TABLE (IF EQUIPPED)

The dinette table is located just inside of the entry door. It cantilevers from the wall cabinet, and pulls out to provide sufficient dining space for four.



The Dinesk table top extends to accommodate additional seating. To extend the table top, find the two release levers located under the long edge (they are coated in yellow). Pull the levers toward you simultaneously to release the table, then pull the table top toward you (outward from the wall).

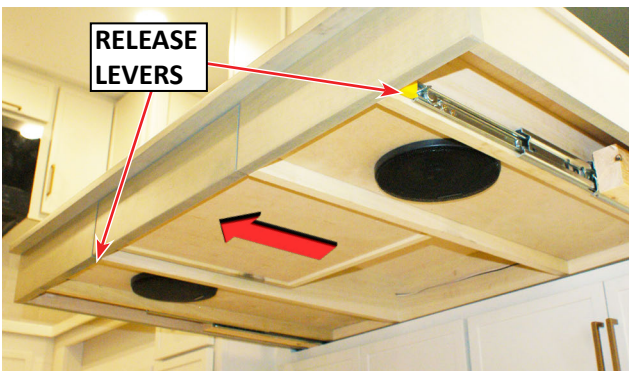

⚠ WARNING

Always be certain the dinesk table top is retracted and latched in place PRIOR to travel. Failure to do so may damage allow the table to shift in transit, resulting in damage to the RV interior.



There is a hidden silverware drawer located in the long edge of the dinesk. This drawer latches magnetically and requires a slight pull to release.



+ NOTICE

Some floorplans may be equipped with a dinette booth instead of the dinette table, ottoman, and chairs.

⚠ WARNING

All dinettes, including the ottoman and dinette chairs **MUST** be secured for transit. If they are not secured, the chairs, ottoman, and other components may shift during transit resulting in damage to the interior of the RV.

To secure dinette chairs for transit slide chair frame closest to slide out wall into attached metal chair brackets (circled in yellow). Use included velco straps (2, circled in blue) to secure second chair to chair that has been secured in metal frame.



To secure ottoman for transit use black nylon securement strap with buckle (highlighted in yellow box) which is attached to the slide out wall. To secure ottoman wrap one side of the strap over the top of ottoman, while wrapping the other side of the strap underneath the ottoman, then secure plastic buckle, and adjust strap as needed.



B. OTTOMAN (IF EQUIPPED)

The ottoman functions as part of the dinette table seating and provides seating for up to two people at the dinette table.

This ottoman is versatile and can be moved from the dinette table for use in front of the sofa. The picture below shows the ottoman in "Dinette Mode".



The ottoman can be moved to in front of the sofa to utilize as a coffee table.



SEC.14 FURNITURE

The ottoman also features a “desk mode”. Grab on to each short end of the hardwood top of the ottoman and pull up and slightly toward you to lift the top into desk mode. This also will permit you to access the storage within the ottoman. See picture below.



Finally, the back cushion from the dinette is attached to the wall with a series of magnets. This cushion can be removed from the wall and placed on top of the ottoman to function as a cushion. See picture below.



C. ENTERTAINMENT RECLINER SOFA (IF EQUIPPED)

Your unit may also be furnished with an entertainment recliner sofa. It is equipped with reclining mechanisms, a center storage console. To operate the recliners, while seated, pull on the handle between the seat and arm of the sofa.



To retract the recliner, press down on the footrest with your feet until retracted into place.

D. TRI-FOLD SOFA BED (IF EQUIPPED)

Your Model I may be equipped with a tri-fold sofa bed. This sofa folds out to provide additional sleeping space.



To fold the sofa to a bed, remove the back cushions and pull the base seat cushion up from the back.



Pull the sofa bottom cushion upward to expose the legs below.



Swing the legs down into position to support the end of the bed.



Lower the end of the bed to place the legs on the floor, then fold the sofa back forward and down to fill the gap. Sofa bed is ready for use. .



SEC.15 ENTRY DOOR & STEP SYSTEM

A. ENTRY DOOR

Your RV is equipped with a Lippert entry door. The handle features an integral lock, locking latch and deadbolt lock for added security.



1. Open the entry door fully.
2. While holding on to the step, slide the blue lever to release the step from the door jamb.



B. ENTRY DOOR STEP SYSTEM

⚠ WARNING

It is important that you have a good grasp on the step as you are lowering the step system. A failure to hold on to the step firmly could result in the step system dropping suddenly and hitting you on the head, neck, shoulder, or face resulting in injury.

Your entry doorstep stows inside of the entry doorway. To deploy the step:

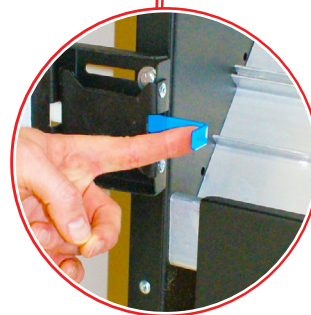

3. Slowly walk backwards and allow the step to lower to the ground.



4. The legs on the step can be extended or retracted to stabilize them on the ground.

To extend or retract the legs, press the metal tab in on the bottom of the stair rails and position each leg to the desired location.

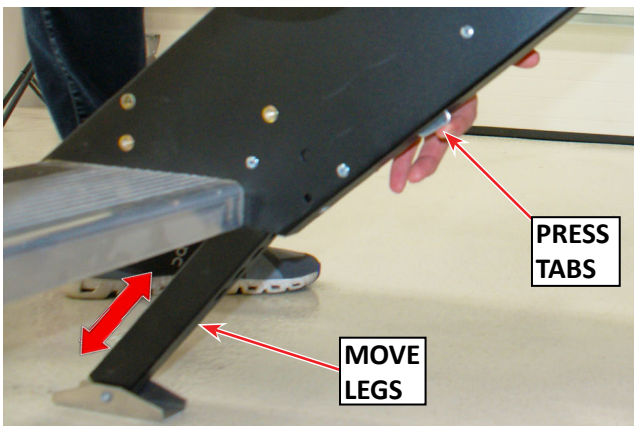

⚠ WARNING

When putting the step away for travel, it is important that you ensure the blue latching mechanism is properly latched to the entry door jamb. Failing to do so could result in the step system detaching from the door jamb in transit resulting in damage to the step, entry door, and potentially other interior components of the RV.

SEC.16 AWNINGS

C. ENTRY DOOR HANDRAIL

Your RV is equipped with a telescoping handrail to facilitate safe ingress and egress into and out of the RV. The picture below shows the location of the handrail and shows the handrail in the extended position. It is held in place for transit utilizing a magnet.

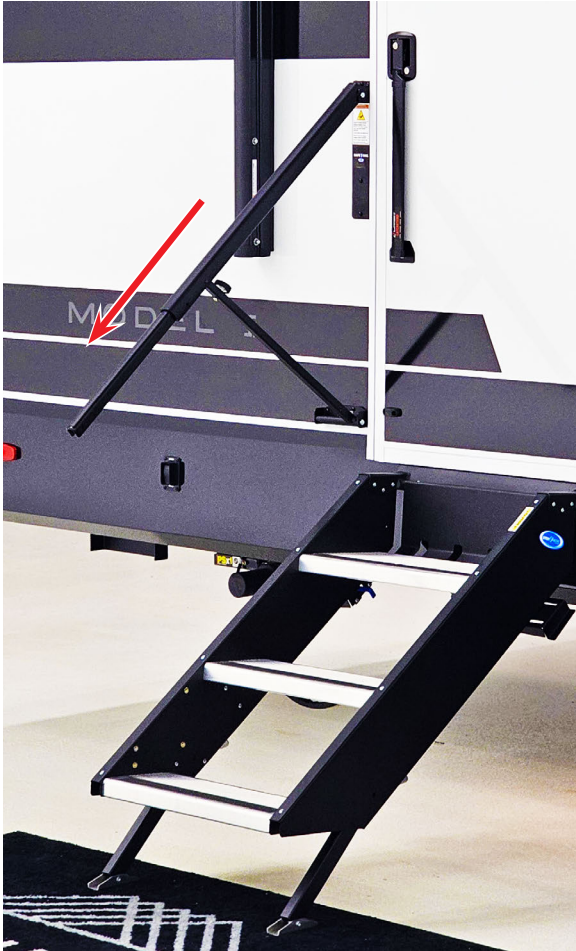

To Deploy the Handrail:

1. Remove the travel cotter pin (if installed) and grab the handrail at the bottom. Pull outward into the full extended position.

2. There is an inner and outer channel that comprises the handrail. Once the handrail is extended in step (1), firmly grab the inner channel located at the bottom of the handrail and pull it down and outward until the inner channel is fully extended.
3. Reverse steps (2) and (1) above to stow the handrail for travel. Be sure to fully seat the handrail so that the magnet engages to the side wall of the RV. Insert the travel cotter pin.

D. ENTRY DOOR HANDLE EXTENDER



The entry door exterior handle has an extender that allows you to open the entry door while standing on the ground, without climbing the entry steps.

NOTE: Multiple awning manufacturers may be utilized in your Model I RV. See page 151 for Dometic awning information - see page 158 for Lippert awning information.

A. MAIN AWNINGS—DOMETIC 9100 SERIES (IF EQUIPPED)

The Dometic 9100 Series Power Awnings installed on your Brinkley RV are operated by 12V electric motors and can be controlled by the awning switches found on the OneControl app or at the Command Center:

COMMAND CENTER



1. General Safety

⚠ WARNING

Do **NOT** modify this product in any way. Modification can be extremely hazardous.

⚠ WARNING

IMPACT OR CRUSH HAZARD. NEVER leave an open awning unattended. Keep awning stowed (closed) when snow, heavy rain, wind, and severe weather conditions are expected. Failure to obey this warning could result in death or serious injury.

⚠ WARNING

IMPACT OR CRUSH HAZARD. Do NOT allow water to pool, snow to accumulate, or heavy debris on awning fabric. Do **NOT** hang or place anything on awning. The awning will become unstable, and could bend or collapse. Failure to obey this warning could result in death or serious injury.

⚠ CAUTION

PINCH HAZARD. Maintain a horizontal distance of at least 16" between fully open awning and any permanent object. Failure to obey this caution could result in injury.

2. Opening the Awning

- Press and hold the extend button for the awning from the Command Center, or the OneControl app. The awning will automatically stop when the extend button is released. This permits you to either fully extend the awning or leave it partially extended/retracted.

SEC.16 AWNINGS

- When fully extending the awning, verify that the valance is in the correct position. If the awning is over-extended, press the retract button briefly until the valance is in the correct position (Fig. 2).



⚠ WARNING

IMPACT OR CRUSH HAZARD. Do NOT allow the awning to remain in over-extended position as this could trap heavy debris, or could cause water to pool or snow to accumulate on awning fabric. This weight will cause awning to become unstable, and bend or collapse. Failure to obey this warning could result in death or serious injury.

3. Awning Lights

The awning lights can be turned off at the Command Center or the OneControl App, or the OneControl panel. There are dedicated switches for the awning lights at each source.

4. Setting the Awning Position

a. Adjusting the Awning Pitch

The fabric roll tube assembly (FRTA) will be lower than the RV's awning rail when the awning is fully extended. This pitch (slope) will help accommodate water runoff. If a steeper pitch is desired, the FRTA must be lowered.

TO LOWER THE FRTA:

1. With the awning fully extended, loosen the adjustable pitch arm assembly (Fig. 3).

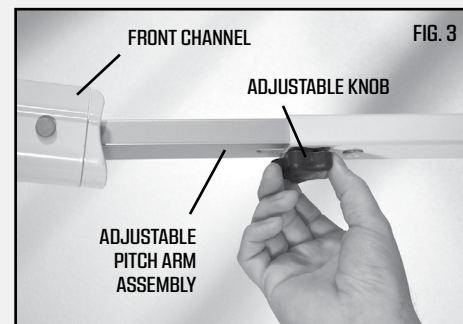

2. While holding the top arm assembly in place, tightening the adjustable knob to hold the desired pitch (Fig. 4).

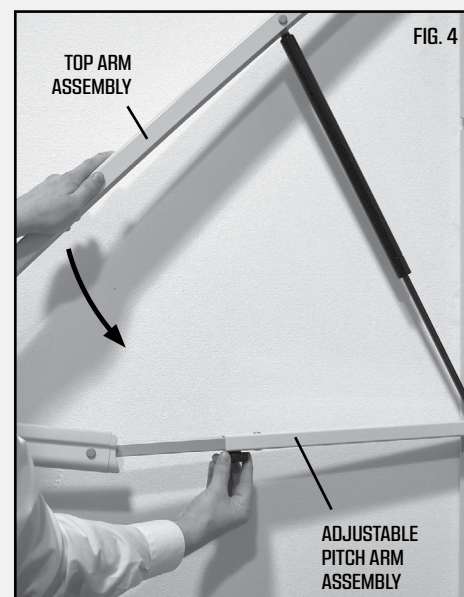

⚠ CAUTION

PINCH HAZARD. Keep clear of openings around the adjustable pitch arm assembly while adjusting the pitch. The adjustable pitch arm assembly will telescope and could lead to injury if caution is not exercised.

+ NOTICE

Do not permit the corner of the entry door to come in contact with the awning fabric. Contact can lead to premature wear or tearing of the awning fabric.

⚠ WARNING

IMPACT OR CRUSH HAZARD. ALWAYS lower one side of the awning hardware to shed water. Otherwise, water could pool on the awning fabric. Do NOT allow water or snow to accumulate on the awning fabric or the awning will become unstable and could bend or collapse. Whenever heavy rain or snow is expected, retract the awning. Failure to heed this warning could result in death or serious injury.

b. Prepare Awning to Shed Water

Lowering one arm assembly into the water shed position will allow water to run off the awning during light rain.

To Set the Awning to Shed Water:

1. With the awning fully extended, verify the top arm of the assembly is fully extended on the side nearest the entry door and the adjustable knob is tightened.

2. Loosen the adjustable knob on the adjustable pitch arm assembly that is furthest away from the entry door (**Fig. 3**).
3. Pull the top arm assembly down on the arm furthest from the entry door until the awning slope is at least 10 degrees or 9 inches (22.86 cm) lower than the other arm assembly (**Fig. 4**) (**Fig. 5**).
4. While holding the top arm assembly down in the desired position, tighten the adjustable knob to set the pitch in place (**Fig. 4**).

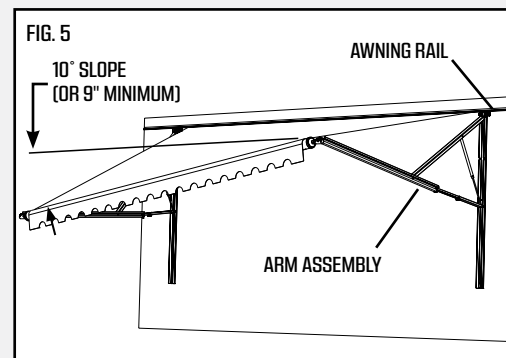

+ NOTICE

Pitching the awnings away from the entry door serves two purposes. First, it helps to ensure that the entry door does not come in contact with and damage the awning fabric. Second, it causes the water to run off away from the entry door to prevent you from getting soaked when entering or exiting the RV during rain events.

5. Closing the Awning

- a. To close the awning, please follow these steps.

CLOSING THE AWNING:

1. Loosen the adjustable knobs to allow the awning to reset to the original position. (Fig. 3). Then lightly tighten the knobs on both arms to help ensure the awning does not rattle during travel. As a test, pull the top arm assembly down to verify the knob is not too tight. It should still slide freely.
2. Press and hold the retract awning button located on the Command Center or OneControl app until the awning is fully closed. Note that the awning will stop when you release the button.

Fig. 6 (below) provides additional guidance on the various components that make up the awning arms. It also highlights the main pinch points of the awning arms that are the subject of the multiple cautions and warnings contained in this section of the manual.

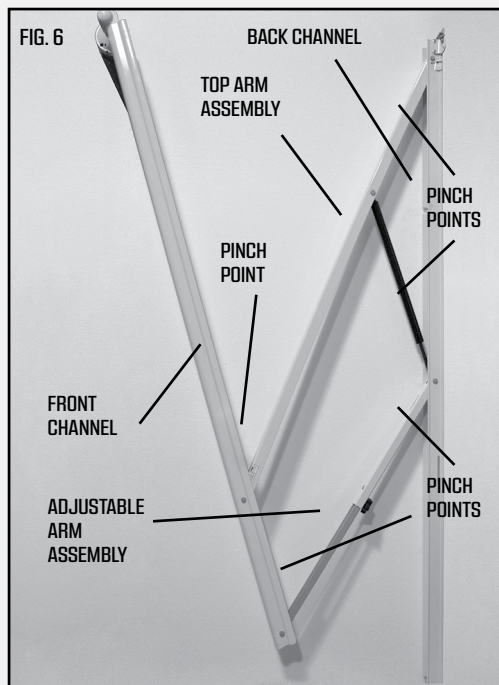

b. Preparing the Awning for Travel

- The main battery disconnect should be in the off position to ensure that power is not supplied to the awning during travel.
- The travel battery disconnect should be in the on position during travel. This disconnect provides power to the battery, brakes, running lights, and solar components. It does not supply power to the awning.
- Ensure the awning is fully retracted and tight against the sidewall of the RV.
- Visually inspect the awning arms and components to ensure there is no damage that could permit the awning to extend during travel.

6. Manually Overriding the Awning

In the event of a power failure or faulty awning motor, it may be necessary to close the awning manually. There are two methods to close the awning manually. Perform the procedure under “A. Auxiliary Power Method” first. If this method is unsuccessful, then proceed to the procedure under “B. Pull Strap Method”.

+ NOTICE

If the awning is closed manually, it will require service by a qualified service technician prior to further use. First, rule out simple causes for power failure. These include:

- a) confirm RV is not disconnected from power
- b) the awning fuse is not blown, c) the RV battery has sufficient charge. Move on to Section A below if the issue remains unresolved.

+ NOTICE

The awning light and awning motor are on different circuits. If the awning light works and the awning motor does not, check the awning motor’s fuse before closing the awning manually.

a. Auxiliary Power Method

When the awning is in the open position and 12VDC power to the awning has been lost, the awning may be closed by supplying auxiliary power (from an external source) to the awning motor. A 12VDC automotive battery or 12VDC drill battery may be utilized as the external power source.

⚠ WARNING

ELECTRICAL SHOCK HAZARD. Disconnect power from the awning before accessing wire connections. There may be issues mimicking a power failure with electrical current still present, or power may return unexpectedly. Failure to heed this warning could result in serious injury or death.

MANUALLY OVERRIDING THE AWNING WITH AUXILIARY POWER:

1. Loosen the adjustable knobs (**Fig. 3**) to allow the awning to reset to its original position. Then, lightly tighten the knobs on both arm assemblies to help ensure rattle-free travel.
2. Disconnect 120VAC power from the RV and 12VDC power to the awning.
3. Unplug the motor connector from the hardware connector. This is located on the upper part of the arm on the right hand side of the awning (**Fig 7**).

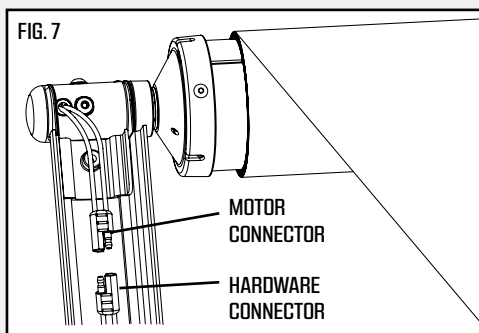

4. Connect 16 gauge (minimum) wire leads (user supplied) to the motor connector and tape in place with electrical tape. **DO NOT** connect to the hardware connector. Match the wire lead colors to the motor wire colors (black to black, red to red)

5. Connect the other end of the wire leads to the 12VDC external power source until the awning fully retracts to its closed position:

- a. Connect the red wire to the positive (+) terminal of the external 12VDC power source. The positive (+) terminal must have a 3A in-line fuse installed.
- b. Connect the black wire to the negative (-) terminal of the 12VDC external power source. Disconnect the wire leads from the power source once the awning fully retracts.

+ NOTICE

The awning will extend versus retract if the wire leads are reversed polarity.

6. If the awning does not move (after confirming the connections and charge on the external power source), the motor may be defective. Proceed to subsection **“B. Pull Strap Method”**.

b. Pull Strap Method

Utilize this procedure if the prior method failed to close the awning. This method requires utilization of a 5/32" hex key, the provided strap located in your Owner's Information Packet, and the assistance of one other person.

SEC.16 AWNINGS

MANUALLY OVERRIDING THE AWNING WITH A PULL STRAP:

1. Make sure the knobs are only lightly tightened on both arm assemblies (Fig. 3).
2. Make sure the motor connector is disconnected from the hardware connector (Fig. 7).
3. Insert the supplied pull strap into the utility slot of the FRTA. The slot is located on the ends of the roll tube. Slide the strap to the center of the awning tube (Fig. 8):

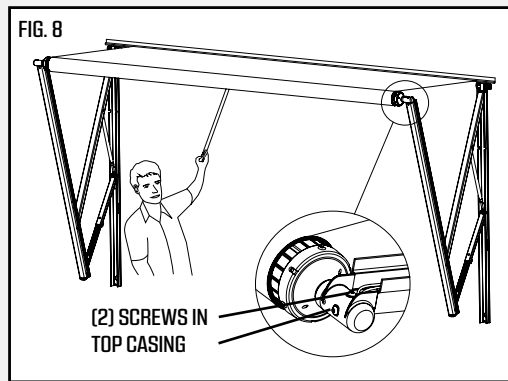

4. Have one person hold the pull strap firmly to relieve the pressure off of the helper spring located in the awning tube (FRTA).

⚠ WARNING

The FRTA is under spring tension, which will attempt to close the awning quickly and unexpectedly. Failure to utilize a second person to hold the awning roll in place while performing the next steps could result in death or serious injury

5. While one person is still holding the pull strap firmly, the other person will remove the two screws at the top and back of the right side casing. Save these screws for reinstallation later (Fig. 8).

⚠ WARNING

PINCH HAZARD. Keep CLEAR of the arm assemblies while closing the awning. The arm assemblies will fold and close against the back channel of the awning arms. Failure to heed this warning could result in death or serious injury.

6. Carefully and slowly roll the awning fabric on to the tube. This process requires the person not holding the strap to manually roll the fabric onto the FRTA until the awning is fully retracted. The person holding the strap will assist by gently relieving pressure on the FRTA to permit the awning to retract and the fabric to roll smoothly and evenly onto the tube.

+ NOTICE

Be sure to avoid bulges or creases in the fabric when retracting to avoid the potential of damaging or stretching the awning fabric.

7. Once the awning is fully retracted, align the holes and reinstall the two screws into the top right hand casing.

⚠ WARNING

Failure to reinstall the two screws into the top right hand casing prior to travel could result in the awning extending quickly and unexpectedly during travel, potentially resulting in death or serious injury

8. Do NOT reattach the wiring to the awning. Leave the wire harness disconnected.
9. Transport your RV to a qualified service center to have the awning serviced.

7. General Care and Use

a. Precautions

+ NOTICE

Failure to heed the following notices could damage the product or property:

- Do NOT use insecticides or other sprays near awning fabric. These could cause stains, and could adversely affect fabric's ability to repel water.
- Do NOT expose awning to adverse environmental conditions, corrosive agents, or other harmful conditions.
- Do NOT allow corner of entry door to contact awning fabric. Otherwise, premature wear or tearing of awning fabric could occur.
- NEVER close awning (for storage) when wet. The combination of moisture and dirt could result in mildew, discoloration, and stains.
- If it is necessary to roll up awning (temporarily) while it's wet, make sure you roll it out and let it dry (as soon as conditions allow) before rolling it up again.
- Do NOT allow dirt, leaves, or other debris to accumulate on awning, which could cause abrasion and stains. Mildew could grow on dirt and organic debris causing permanent discoloration, stains, and odors to awning fabric.

b. Hardware Maintenance

+ NOTICE

Do NOT use strong chemicals or abrasives to clean parts, as their protective surfaces will be damaged.

1. Clean awning hardware (as needed) with a mild surface cleaner.

+ NOTICE

Do NOT use silicone sprays near labels. Otherwise, the label's adhesive bond to product surfaces could weaken.

2. Apply silicone spray lubricant as needed to keep the fabric roller tube assembly's moving parts operating smoothly.
3. Lubricate all sliding surfaces of arm assemblies with silicone spray as needed.

c. Fabric Maintenance

Vinyl fabric offers the advantage of durability and water resistance.

Wrinkling is a normal characteristic of vinyl. Wrinkling may be more noticeable when retracted, and after prolonged periods of stowage (rolled up). Leave awning open during warm weather to minimize the wrinkling over a period of time.

CLEANING THE AWNING FABRIC:

1. Mix 1/4 cup dish soap and 1/4 cup bleach to 5 gallons of fresh water to use as cleaning solution.
2. Do NOT use abrasive or corrosive cleaners, mildew removers, or hard bristle brushes on awning fabric. Liberally drench open awning fabric with cleaning solution.
3. Close awning, let it soak for 5 minutes, then open awning again.
4. Remove solution COMPLETELY from awning fabric. Bleach will degrade awning fabric if NOT completely rinsed off. Thoroughly hose off top and bottom of fabric with clean water.

SEC.16 AWNINGS

Repeat as necessary to completely remove the solution.

5. **NEVER** close the awning (for storage) when wet. the combination of moisture and dirt could result in mildew, discoloration, and stains.

Allow awning to dry thoroughly before stowing (rolling up).

VINYL REPAIR:

1. Apply a very small dab of VLP (Vinyl Liquid Patch) on the tip of a cotton swab. VLP is available from Dometic Corporation. Reference part number 3314216.000 when ordering.

2. Gently roll the cotton swab around the pinhole. the VLP will melt the coating (on fabric) and that will quickly fill in pinholes and blend with all colored vinyls.

3. **NEVER** close (roll up) awning when vinyl liquid patch is wet. Otherwise, damage to other parts of awning fabric (melting through layers) will occur. Allow VLP to dry thoroughly before stowing (rolling) up awning.

B. SOLERA POWER AWNING (IF EQUIPPED)

The Solera® Power Awning installed on the RV is operated by an electric motor and can be controlled by the Awning switch found within the RV. This switch can be located on the Command Center in the cabinet just inside the RV. The installed awning contains adjustable, friction joint arms rather than traditional locking pivot arms. This allows for easy adjustment and manipulation of pitch when needed. It also helps to prevent damage to the arms during wind events.

C. AWNING EXTENSION

1. Prior to operating the awning, make sure the battery is fully charged and the RV is connected to external shore power.
2. Press and hold the **EXTEND** button found on the command center to fully extend the awning.
3. For partial extension, press and hold the **EXTEND** button until the awning reaches the desired position.

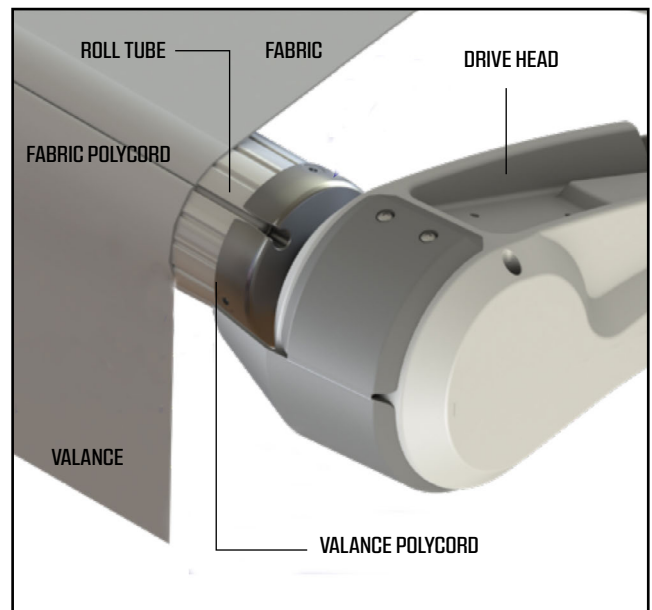

+ NOTICE

Maximum extension is met when the fabric is completely unrolled and taut. When fully extended, the valance seam and a section of the roll tube will be visible. As soon as this is seen, be sure to stop extension right away. The awning canvas should always be on top of the roll tube rather than under. If the awning is hyper extended the awning will begin to retract in reverse and will flip the canvas to the under portion of the roll tube. If this occurs, press the **RETRACT** button until the awning fully extends and then corrects to retraction.

⚠ WARNING

Keep clear of any and all moving parts while the awning is in operation. As the awning functions and closes against the unit, there is a risk of being pinched, cut, and crushed.

D. RETRACTING THE AWNING

1. Prior to operating the awning, make sure the battery is fully charged and the RV is connected to external shore power.
2. Double tap the **RETRACT** button found on the command center to fully retract the awning.
3. For partial retraction, press and hold the **RETRACT** button until the awning reaches the desired position.

+ NOTICE

This manual is intended to provide operational instructions for the Solera® Power Awning installed on the RV. Operating the awning in any other manner other than what is described within this manual, or the manual provided by the manufacturer may result in damage to the awning or RV, the warranty, property damage, and/or personal injury.

+ NOTICE

The pitch of the awning does not need to be corrected to retract the awning.

⚠ CAUTION

While there is heavy wind, heavy rain, or during extended time away from the RV, the awning should be fully retracted. This will help to prevent damage to the awning and RV.

⚠ CAUTION

Do not tie down the roll tubes on the awning. This prevents the free floating, tension arms from functioning as designed. Doing so may result in damage to the awning or to the RV.

E. PITCH ADJUSTMENT—SOLERA AWNINGS

If water begins to collect on the awning, the pitch of the awning will automatically adjust to purge the access water. This is to prevent damage from occurring to the awning and may occur without notice.

SEC.17 RV EXTERIOR CARE

Adjusting the pitch of an awning will allow water to runoff as it begins to collect on the canvas and can be done by adjusting one awning leg lower than the other.

SETTING THE PITCH:

1. Begin by extending the awning to the desired position.
2. Select the side that is most convenient for water runoff.
3. Adjust the leg by pulling downward on the joint until the desired pitch is obtained to allow for proper water runoff to occur.
 - a. Major adjustments do not need to be made and should be performed on an as needed basis.
 - b. Never push the joints in an upward motion. Doing so may cause additional stress on the strut causing damage or failure.
 - c. The bolt and washer on the joint (**Fig. A**) allow the arm to remain in the set position.

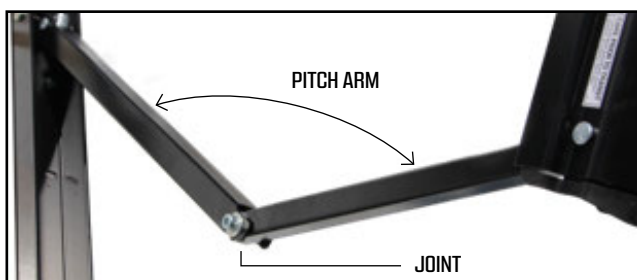

+ NOTICE

The pitch of the awning does not need to be corrected to retract the awning.

+ NOTICE

If the manipulated arm does not hold in position, tighten the bolt at the joint displayed in the figure above.

F. MAINTENANCE—SOLERA AWNINGS

Proper maintenance and usage can help to extend the longevity of the awning. If you must retract the awning while the canvas is wet, fully extend the awning when conditions allow so proper drying can occur. This should be done right away to help prevent mold and mildew from forming.

CLEANING THE AWNING CANVAS:

1. Mix ¼ cup of dish soap with five gallons of warm water.
2. Apply the mixture to the canvas and fully retract the awning for five minutes. This will allow the mixture to encounter both sides of the canvas material.
3. After the allotted time, fully extend the awning and rinse the canvas with fresh water.
4. Repeat as many times as needed.

+ NOTICE

If mildew forms, it is not on the fabric itself, but formed on the accumulated dust and debris. If mildew is present, clean the canvas material immediately.

A. GENERAL

The exterior portion of the RV is composed of many materials including, but not limited to: Fiber-glass, automotive paints, plastics, sealant, aluminum, and rubber. The longer a foreign substance remains on the finish of the RV, the more likely it is to damage it. It is recommended that you keep the exterior of the RV cleaned and maintained on a continuous basis. This can be accomplished by frequently washing and waxing the RV with the recommendations outlined in the below sections.

The following materials may cause damage to the surface of the RV resulting in corrosion, staining, chemical spotting, and premature wear:

- Road dirt, dust, and debris; Including, but not limited to, road salt, de-icing chemicals, tar, gravel, oils, and other car related fluids.
- Tree sap, bird feces or droppings, and bugs.
- UV exposure, humidity, and moisture.
- Industrial fallout, hail, acidic rain, and other possible pollutions.

B. EXTERIOR CLEANING

Frequently washing the RV can help to protect it against environmental elements, such as acids, debris, salts commonly found in air, water, and snow, and de-icing chemicals.

- Any time the RV encounters foreign materials, the RV should be washed.
- Try to avoid parking under trees, near saltwater bodies of water, or in direct sunlight.
- When ice or snow is present, never scrape the surface of the RV to remove, always brush both off with a soft bristle snow broom.

- If chemicals or solvents such as anti-freeze, gasoline, oil, etc. encounter the surface of the RV, rinse the affected area immediately.
- Bird and insect droppings should be rinsed off daily.

C. WASHING

- Never wash the RV in direct sunlight. Park in a shaded area and allow the RV surface to cool before beginning.
- First spray the RV with water to remove loose dust and debris.
- Next, wash the RV.
 - Use a mild car wash detergent and water mixture.
 - Use a soft debris free washing mitt or sponge.
 - Wash from the top down of the RV.
- Once fully washed, the RV should be thoroughly rinsed.
- Upon rinsing, immediately dry with a chamois or soft cloth.
- Joints, flanges, wiper seals, doors, etc. should be carefully hand cleaned to remove hidden or covered dirt and debris.
- **NEVER** use an automatic car wash on the RV.
 - Excessive heat may distort materials and cause resins to become damaged.
 - Excessive pressure may cause water to flood undesired areas within the RV.
- Avoid using high pressure water systems to clean the RV. This may force water into undesired locations that may result in damage to an electrical system, component, or the RV.

SEC.17 RV EXTERIOR CARE

- When using any form of pressure sprayer, extreme caution should be used near or around any door, attachment, window, vent, appliance, etc.
- Keep the tip of the sprayer roughly 16 inches or further away from the surface of the RV.
- If hazing or chalking occurs, wash, and wax a small trial area to see if luster returns.
- Have the RV inspected by your Dealer if the exterior becomes cracked or nicked.

D. DURING COLD WEATHER

If the slide-out room, compartment door, or entry door becomes frozen shut, do not force it open. Doing so may result in damage to the seals, gaskets, and slide motor. If seals become damaged, they will no longer be weatherproof.

To open:

- Apply warm water on the gasket or seal to melt the ice. Do not use boiled or hot water.
- Once the ice melts and the door or slide-out can be opened, thoroughly dry all water present.

+ NOTICE

Salt and other chemicals utilized on roads during winter months may cause damage to the RV and should be rinsed immediately. Rust may form if it is not cleaned from the metal surfaces and will not be warrantable.

When exposed to salts and other chemicals during winter:

- Rinse the under portion of the RV and all other parts of the RV that may have been exposed.

- After rinsing the RV, dry all water from all doors, slide-outs, and rubber seals or gaskets.

Paint Manufacturer Maintenance Guide:



E. RV WAXING

The RV should be waxed once or twice a year, or when water no longer beads upon the surface of the RV. Take a soft cloth and apply a small amount of wax to the surface of the entire RV.

- Never wax in direct sunlight.
- If surfaces are warm, allow them to cool before beginning.
- Do not apply wax to weather stripping.
- If the wax stains the surface, remove with a warm water and a soft cloth.
- Once the wax is fully dry, hand buff the RV with a dry, soft cloth.
- Repeat this process until desired results are obtained.

+ NOTICE

DO NOT use a buffing compound or buffer on the surface of the RV as it may damage the exterior surface. If further assistance is needed, please contact your local RV body professional.

F. RV POLISHING

If the painted surfaces of the RV become dulled, damaged, or lose their color, a mild polishing compound can be used. Polish a larger area than that of the damaged area to help to blend in the polished area. After the area has been treated

with polish, thoroughly remove the polish from the surface and re-apply a coat of wax.

+ NOTICE

DO NOT use high-abrasive waxes on exterior walls, garnishes, moldings, grilles, etc. Abrasive waxes may be effective in removing stains, but in the process will also remove top coatings on the surface.

G. DAMAGED PAINT

After returning from a trip, all surfaces exposed to the road or near the tires should be inspected for paint damage that may have resulted from flying debris. If painted areas become damaged, they should be touched-up as soon as possible with touch-up film or paint. To purchase touch-up films or paints, please reach out to your closest automotive facility capable of matching paint. Please also refer to [Section 17N](#) (next page) pertaining to the RV frame/chassis.

H. PLASTIC COMPONENTS

To clean plastic components use a soft cloth, sponge, or chamois with warm water. Refrain from using abrasive cleaning tools, soaps, or waxes as they may cause damage to the surface of the plastic components.

I. CHROME PARTS (IF EQUIPPED)

To prevent spotting or corrosion from occurring on chrome parts, always pat dry when exposed to moisture. When washed, rinse with water, thoroughly dry, and apply a non-abrasive wax for protection. If the chrome becomes severely damaged or pitted, chrome polishes can be used.

J. EXTERIOR ROOF

The Superflex Alpha Ply membrane and vents on the roof should be inspected and cleaned twice a year with a mild soap and water solution.

- When cleaning the surface of the roof, refrain from using sharp tools such as a putty knife that could puncture or tear the membrane.
- All areas should be cleaned with a medium scrub brush.
- Once fully clean, rinse with water and allow the surface to air dry.
- If seals need to be reapplied, clean the area with a non-abrasive house cleaner first (i.e., Spic-N-Span).
 - Always prep and re-seal an area **AFTER** the roof has already been washed.
 - Cleaners and Solvents should **NOT** be used in the washing stage. Cleaners and solvents may damage existing seals or cause premature breakdown.

+ NOTICE

Never use petroleum distillates when washing the roof. This may cause irreversible damage.

⚠ WARNING

When on the roof, do so with great caution and navigate the area on your hands and knees. This will help to distribute your weight and reduce your risk of falling. As the water and mild soap solution are applied to the roof material, it can become very slippery.

SEC.17 RV EXTERIOR CARE

K. VENTS

There are various vents and appliance access panels that will need to be kept clean and clear of debris and obstructions. Holding tank vents will also need to be regularly inspected for possible obstructions caused by birds, insects, leaves, etc.

L. SEALANTS

There are many forms of sealants used on your RV including butyl tape, putty, encapsulated foam, silicone, roof sealant and foam. Each sealant has its own unique way to help protect your RV. Although many seals do not have a set lifespan, due to environmental factors, deterioration may occur over time. If signs of deterioration are present, please replace the seal immediately to prevent possible damages.

Exterior sealants should be inspected every six (6) months and replaced as needed every year.

Dealer Expectation:

- Inspect ALL sealants every three (3) months as the RV is on lot and replace as needed.
- Replace all seals once a year as preventative care.
- Resolve any water damage that occurred due to the lack of preventative care.

If water is present inside the RV, immediately inspect the RV for leaks. If the origin of the leak cannot be determined and remedies, have your Dealer inspect the RV right away. Failure to properly maintain the RV or to correct a leak may result in extensive damage to the RV and is not deemed warrantable.

Please contact your Dealer or Brinkley RV with questions, or concerns.

M. ROOF LADDER

There is a roof access ladder provided and installed on the rear of your RV. This will allow you to gain access to the roof. The roof contains decking under the rubber roof membrane that will allow you to walk on the roof to perform maintenance. This should be done with caution.

WARNING

The installed ladder is capable of handling up to 300 lbs. When in transit, no items should be attached to the ladder at any time.

N. RV FRAME/CHASSIS

Road debris, rocks, automotive fluids, sand, salts, and other road chemicals used during winter months may cause damage to the frame's exterior paint. As this protective coat becomes compromised, the frame becomes susceptible to rust and other forms of deterioration.

Regularly inspect all exposed areas of the frame and repaint damaged areas after thoroughly cleaning.

O. WINDOWS

Condensation and heavy rains may allow water to accumulate within the window track. Regularly dry and clean this area to prevent mildew from forming.

The glass within the window can be cleaned using a glass cleaner and soft cloth or paper towel. After being cleaned, the glass should be dried with another soft, dry cloth.

P. RV STORAGE PREPARATION

To help prevent problems from occurring, you should always prepare the RV before storing over extended periods of time. This preparation will not

only protect your RV, but it will also make removing the RV from storage must easier.

1. Inspect the roof and all other surfaces for damages that may pose a threat for water to seep into the RV. Such leaks may go unnoticed until damage is already done.
2. Ensure all windows, roof vents, compartment doors, and entry doors are securely closed.
3. Turn **OFF** the power to the refrigerator.
 - a. Once defrosted, the freezer and refrigerator should be cleaned.
 - b. Place baking soda and crumpled newspapers in the refrigerator to help eliminate odors.
4. Fully shut the propane cylinder valve(s).
5. Cover all external vents, exhausts, air conditioner, and outlets with mud dauber/rodent screens to prevent rodents from entering. **THESE MUST BE REMOVED PRIOR TO CONTINUING USE.**
6. **DISCONNECT** all external shore power.
7. Fully retract the leveling system and refrain from using while in storage.
8. Ensure all water tanks and water lines are drained.
9. Properly flush all holding tanks including the freshwater tank, gray tank, black tank, and the water heater.
10. Properly winterize the water system.
11. Use the main battery disconnect to fully disconnect all 12v power. Remove the battery from the RV and place on a battery maintainer for proper storage.



EXAMPLE OF A BATTERY MAINTAINER (CUSTOMER SUPPLIED)

12. Thoroughly clean the inside of the RV removing any possible foods for rodents to be attracted to.
13. Wash the exterior surfaces of the RV.
14. If possible, store the RV indoor, under a roofed location, or under a breathable RV cover.
15. For UV and weather protection, cover the tires with tire covers.

Please see winterizing instructions in [Section 130](#).

+ NOTICE

Before winter months, ensure the RV's plumbing system is properly winterized. Failure to do so may result in frozen pipes and costly damages.

+ NOTICE

Damage caused or created by rodents or insects is not warrantable. Please take proper measures to prevent infestation or entry.

A. CLEANING THE INTERIOR

To increase the longevity of the RV, maintenance should be performed on a regular basis following the proper care procedures. In addition to this manual, please follow all instructions provided within the provided manufacturer's manual.

+ NOTICE

Only cleaning products recommended within the manufacturer's manuals and this manual should be used on your RV. Using improper chemicals and cleaning agents may result in surface damage within the RV. Always test a small, out of sight area with the cleaning agent before using on the entire surface. Contact your Dealer for additional information and assistance.

⚠ WARNING

NEVER use flammable agents or sprays to clean your RV.

B. TABLES, CABINETS, AND DRAWERS

- Regularly dust all hardwood surfaces including cabinet doors and drawers, tables, and cabinet fronts using a soft cloth and cleaning polish or mild recommended solution.
- Do not use silicone oils or ammonia-based products on any surface. Prolonged use will result in damage to the surfaces.
- Properly clean accidental spills as they occur.
- Avoid prolonged exposure to direct sunlight, high humidity, extreme cold, or high temperatures. Extreme conditions may result in damage to finish and/or wood products.

C. PANTRY

The design of the pantry was guided by weight limitations and not based on the volume of items. Please bear this in mind as you load and stock the pantry.



- The pantry can be used to store items you wish to take with you as you travel.
- The shelves within the cabinets were designed for common camping items such as paper plates, napkins, cookware, plastic cups, dry goods, etc. all of which are not heavy or bulky.
- Prior to traveling, make sure all loaded items are secure.
- Within the pantry, you will also find an electrical prep conduit that runs directly to the roof of the RV. The purpose of this conduit is to provide a means to run wiring for additional installs to the roof (i.e., solar panel, satellite dish, etc.)

SEC.18 RV INTERIOR CARE

- Locate the access panel under the bottom shelf and remove the cover plate.
- This will allow access to the conduit where wires can drop from the rooftop down into the utility compartment between the kitchen and pass-through storage.

TO ADJUST THE PANTRY SHELVES:

1. Remove the bracket screw found on each end of the shelf. See below.
2. Remove the two rail screws at the location you would like to relocate the shelf. See below in orange.
3. Lift up and relocate the shelf to the desired location.
4. Reinstall the removed screws.



D. WALL, CEILING, AND CABINET PANELING

- Use a solution of a mild soap and warm water.
- Always use a soft cloth or sponge.
- Refrain from using harsh cleaning agents as they may dull the surface color or cause micro scratching. Always test cleaning agent in an inconspicuous area first.
- If a more aggressive cleaner is needed for stubborn dirt or grease, use an all-purpose cleaner.

E. COUNTERTOPS

The main countertops in the RV are an acrylic solid surface. Solid surface is also commonly referred to as “Corian”. This is due to the fact that DuPont was the inventor of solid surface and Corian is their name brand. Although solid surface is highly repairable, special care must be exercised to prevent permanent damage to the countertop edges and surface:

- **ALWAYS** use hot protective pads under any hot pans, dishes, or heat producing appliances.
- **NEVER** use a knife or sharp object directly on the countertops. ALWAYS utilize a cutting board.
- **NEVER** use harsh chemicals or cleaners (i.e., drain cleaners, oven cleaners, grease removers, etc.).
- **NEVER** mix bleach and other cleaning agents.

Solid surface counters are less sensitive and easier to clean. Many commercial surface cleaners and cleaning solutions can be used to remove residue and dirt. Avoid the use of window cleaners as many glass solutions leave a waxy buildup that will dull the surface appearance. Utilize a damp microfiber cloth to clean the surface and dry with a dry microfiber cloth or towel to remove residual cleaner left behind. All countertops should be disinfected on a regular basis. This can be accomplished with disinfectant wipes or diluted household bleach (100:1, one hundred parts water to one part bleach).

F. VINYL FLOORING

Always test a small, out of sight area with the cleaning agent prior to using on the entire surface. If the surface dulls or is otherwise damaged, discontinue use immediately to prevent further damage.

Please see the cleaning guide on the next page for further instructions.

HOW TO TREAT STAINS, SPILLS & SCUFFS

Follow the remedies in order. Unless instructed otherwise, use a clean cloth or towel with the recommended liquids. Always rinse the affected area with clean water after treatment.

STAINS AND SPILLS

Acids, Alkalis	Dye, Dye Markings	Iodine	Vomit
Blood	Food, Candy	Mercurochrome	
Ketchup, Mustard	Fruit & Fruit Juices	Rust*	
Cleaners, Strong Soaps	Grass	Urine, Excrement	

REMEDY

- Scrub area with Congoleum Bright 'N Easy No-Rinse Cleaner at full strength.
- Rub area with a 10 to 1 dilution of water to liquid bleach.
- Rub area with isopropyl alcohol.**

**If rust stain does not respond, use lemon juice or a cream of tartar solution.*

PAINT AND SOLVENT SPILLS

Dry Cleaning Fluids	Lacquer	Latex Paints	Nail Polish
Oil-Based Paints	Solvents	Varnish	Wood Stains

REMEDY

- If substance is dry, gently peel it from the floor (avoid sharp instruments that could scratch floor).
- Scrub area with Congoleum Bright 'N Easy No-Rinse Cleaner.
- Rub lightly with mineral spirits, isopropyl alcohol or lighter fluid.

SCUFFS & SMUDGES

Rubber Heel Marks	Scuffs
Shoe Polish	Smudges

REMEDY

There are several methods for removing scuffs on satin-gloss and matte floors. For matte-gloss floors, use recommended methods #1 and #3 only. For satin-gloss floors, all of the listed methods for removal are recommended, depending on the severity.

- Spray Fantastik® Cleaner on the scuff. Let stand for 10-15 seconds and then remove with a sponge or cloth.
- Using a damp sponge, rub scuffed area with a polishing cleaner such as Soft Scrub®. Rinse with a sponge or cloth.
- Wipe scuff with lighter fluid** applied with a clean cloth.
- With a rubbing motion, apply a car polish/cleaner such as No. 7® or similar product on the area, then rinse thoroughly.
- Remove stubborn scuffs with a mechanical buffer equipped with a lamb's wool pad.

***Caution: Isopropyl alcohol, lighter fluid, mineral spirits and paint thinner are flammable solvents. Carefully read and follow cautionary information on label. Keep traffic off treated area for 30 minutes.*

SEC.18 RV INTERIOR CARE

Sweep or vacuum regularly to remove dirt and grit that can abrade, dull, or scratch your floor. Do not use a vacuum with a beater brush, because it may damage the floor's surface. Wipe up spills promptly with a damp cloth or mop. For a more thorough cleaning, use a non-detergent based resilient floor cleaner or a mild soap and water mixture.

G. DINETTE TABLE, OTTOMAN, AND DINETTE CHAIRS

1. Dinette Table (If Equipped).

The dinette table is designed to seat up to four people. Prior to traveling, the chairs must be secured by the provided travel bracket found under the dinette table. Securing the chairs will prevent damage from occurring while traveling. The dinette table is made of hardwood and should only be cleaned using cleaners that are safe for wood products. For additional information on the dinette table, please see [Section 14A](#).

2. Ottoman

The ottoman has a hardwood top and fabric on its' sides. The hardwood portion should only be cleaned using cleaners that are safe for wood products. The fabric portion should be cleaned according to the manufacturer's instructions and only using cleaners suitable for fabric care.

3. Dinette Chairs

The dinette chairs are comprised of metal legs and a vinyl seat. The seat should only be cleaned with products suitable for vinyl cleaning. You should test the cleaner on an inconspicuous area first to ensure that the cleaner does not permanently damage the vinyl or change the color of the seat.

H. ENTERTAINMENT SOFA, HIDE-A-BED SOFA, AND TRI-FOLD SOFAS

1. Entertainment (Recliner) Sofa

The entertainment (recliner) sofa is vinyl wrapped. It should only be cleaned with products suitable for vinyl cleaning. You should test the cleaner on an inconspicuous area first to ensure that the cleaner does not permanently damage the vinyl or change the color of the seat.

VINYL—CARE AND CLEANING:

- Both PVC and Polyurethanes should be cleaned with a mild, water-based shampoo or soap.
- More stubborn stains can be cleaned with a mild, non-alcohol based, cleaning fluid.
- Rinse with clean water after.
- Once cleaned and rinsed, pat dry.

For additional information and recommendations, please refer to the manufacture's manual.

2. Tri-Fold Sofa

The tri-fold sofa is covered in fabric upholstery and should be cleaned according to the manufacturer's instructions and only using cleaners suitable for fabric care. Furniture upholstery should be cleaned on a regular basis by wiping with a soft damp cloth or by vacuuming with a soft bristle attachment. If stains occur on any fabric or surface within the RV that cannot be resolved by following [Section 18I\(1\)](#) (next page), a professional cleaner should be contacted if it becomes stained or soiled.

For additional information and recommendations, please refer to the manufacture's manual.

I. FURNITURE UPHOLSTERY

Furniture upholstery should be cleaned and maintained on a regular basis. This can be done by wiping the surfaces with a soft damp cloth or by vacuuming with a soft bristle attachment. Please see the information outlined within this manual and also in the manufacturers' manuals.

1. Fabric

Brinkley RV is utilizing Richloom Tough Collection fabrics for the sofa, ottoman, and bedspread.

For proper care and maintenance, please see the below instructions.

RICHLOOM TOUGH—PROPER CARE/ CLEANING GUIDELINES

- Both PVC and Polyurethanes should be cleaned with a mild, water-based shampoo or soap.
- More stubborn stains can be cleaned with a mild, non-alcohol based, cleaning fluid.
- Rinse with clean water after.
- Once cleaned and rinsed, pat dry.

All fabrics are also treated with Fortress, a proprietary stain resistance. They recommend blotting any stains with a paper towel to remove excess spill. Then, prepare a mixture of ¼ cup (59.15 ml) mild detergent with 1 gallon (3.785 liters) of water. Spray the mixture on the area and blot again. Repeat until clean. Let the clean area air dry.

For additional information and recommendations, please refer to the manufacture's manual.

2. Vinyl

When vinyl is stained, it should be professionally cleaned only as recommended.

CLEANING VINYL—LIQUID SPILL NO STAIN:

- Gently pat dry with paper towel or a soft cloth.
- Use a water-based cleaner.
- Always pat clean, never rub or oversaturate the area.
- **NEVER** use solvents or harsh chemicals. Adverse reactions may occur to the backing of the vinyl if used.
- **NEVER** dry clean vinyl components. Adverse reactions may occur with use causing the backing of the vinyl to shrink and become brittle.

For additional information and recommendations, please refer to the manufacturer's manual.

+ NOTICE

Using other cleaning methods on vinyl other than what is recommended may produce undesired results and damage to the upholstery items. If this damage occurs, it is not warrantable.

3. ABS Plastic

ABS plastic components will remain composed and only require to be dusted and cleaned on occasion. This can be accomplished with a soft, damp cloth (i.e., drain lines, plastic trims, plastic covers, vents, etc.).

- **NEVER** use abrasive soaps, compounds, or cleaning agents to clean ABS plastic components.
- **AVOID** the use of citrus, acidic, or D-Limonene containing solutions; such cleaners are capable of damaging the ABS plastic material.

SEC.18 RV INTERIOR CARE

J. DÉCOR

1. Glass Décor

Glass cleaner should be used to remove smudges, smears, and spots on the glass décor found within the RV. If there is decorative etching or frosting on the glass, be sure to clean with care in that given area.

2. Window Treatments

For the trim encompassing the windows, dust periodically with a soft cloth and a polish or mild solution. The trim is painted hardwood. Be sure that any cleaners utilized are compatible with painted wood product.

3. Blinds and Shades

Blinds and shades should be occasionally dusted using a vacuum and soft brush attachment or a soft cloth.

K. SHOWER WALLS

The shower walls within the RV should be cleaned with a mild solution of soap and warm water. **NEVER** use abrasive soaps, compounds, or cleaning agents to clean the shower walls.

L. SINK AND SHOWER FIXTURES

A mild soap and warm water mixture should be used to clean the sink and shower fixtures. If hard water spots are present, use a vinegar and warm water solution to clean.

M. STAINLESS STEEL SINK AND APPLIANCES (IF EQUIPPED)

When cleaning stainless steel products, please see the below instructions:

1. Use a soft cloth dampened by a solution of mild soap and warm water.
 - a. Never use abrasive soaps, compounds, cleaning agents, scouring pads, or steel wool.
 - b. Some glass cleaners or cleaners made for stainless steel can also be used. Always perform a trial cleaning when using new products.
2. Carefully wipe the surface, cleaning with the grain of the steel and not against it.
3. Thoroughly rinse the cloth and repeat this process until the appliance surface is clean.
4. Pat dry the surface with a paper towel or dry soft cloth.

N. MAINTENANCE CHECKLIST

Below, you will find a quick reference checklist of all the suggested items that should be regularly inspected and maintained. In addition to this provided checklist, please review the manufacturer's manual for additional information, instructions, warnings, and maintenance routines.

1. Prior to Your First Trip in Your RV

- **INSPECT** and reseal as needed.
- Ensure the propane system is properly inspected for leaks by your Dealer.
- Check the torque on all wheel lug nuts. See [Section 5J](#).
- Clean and sanitize the freshwater tank and system. See [Section 13N](#).
- **TEST** all safety alarms within the RV. See [Sections 4E, 4F, and 4G](#).
- Refer to [Section 5](#) for additional information and instructions.

2. Each Trip

- **INSPECT** the seals and re-seal as needed.
- Ensure the auxiliary battery is fully charged and healthy.
- Verify running lights operate.
- **CHECK** all tire pressures and wear. Don't forget to check the spare. Tire pressure should be checked **BEFORE** the RV is traveled with, or while they are "cold." See [Section 5E](#).
- **CHECK** the torque of all wheel lug nuts. See [Section 5J](#).
- **TEST** the braking system of the RV and the tow vehicle. See [Section 6C](#).

SEC.19 MAINTENANCE

MAINTENANCE ITEM	EVERY TRIP	MONTHLY	EVERY 3 MONTHS	EVERY 6 MONTHS	ANNUALLY	BEFORE/AFTER STORAGE	PROCEDURE TO BE PERFORMED:
							MAINTENANCE SCHEDULES ARE MINIMUM REQUIREMENTS. EXTENDED USE, EXTREME TEMPERATURES, HIGH HUMIDITY OR OTHER EXTREME CONDITIONS WILL REQUIRE MORE FREQUENT MAINTENANCE.
APPLIANCES					X	X	CLEAN AND SANITIZE
		X				X	MAKE SURE BURNER TUBES/VENTS ARE CLEAN/UNOBSTRUCTED
					X	X	CHECK SETTINGS AND ADJUSTMENTS PER MANUFACTURER GUIDE
AWNINGS					X	X	CLEAN MOVING PARTS AND APPLY SILICONE OR TEFLON BASED DRY LUBE
						X	WASH WITH WARM WATER AND MILD DETERGENT
AXLES/ SUSPENSION	X			X		X	CLEAN MOVING PARTS AND APPLY SILICONE OR TEFLON BASED DRY LUBE
				X		X	WASH WITH WARM WATER AND MILD DETERGENT
BAGGAGE DOORS			X			X	SPRAY LOCK TUMBLERS WITH DRY GRAPHITE
		X				X	CONFIRM THAT DOORS SEAL TIGHT AND ARE NOT LEAKING
BRAKES/ WHEEL HUBS					X		CHECK AMP DRAW/SHOE WEAR/ADJUSTMENT (SEE MFG. SPECS)
					X		LUBE BEARINGS EVERY 12 MONTHS/12,000 MILES (AS REQUIRED)
					X		HAVE BRAKES AND HUBS INSPECTED BY A CERTIFIED RV SERVICE TECHNICIAN
ELECTRICAL SYSTEM			X		X	X	TEST ALL GFCI OUTLETS
					X	X	SERVICE GENERATOR (IF EQUIPPED) PER MANUFACTURER'S MANUAL
	X		X			X	CHECK AND SERVICE BATTERIES
ENTRY DOOR(S)			X			X	LUBE HINGES WITH SILICONE OR TEFLON BASED DRY LUBE
			X			X	ADJUST SCREEN DOOR AND LATCH
	X					X	CHECK DOOR LATCHES AND LOCKS FUNCTION PROPERLY

BRINKLEY CUSTOMER CARE: phone: 888.502.3460 or 574.501.4280 / email: CustomerCare@BrinkleyRV.com
 SAFERIDE 24/7 - EMERGENCY ROADSIDE ASSISTANCE: 888.482.5715 / Customer Service: 855.963.1770

MAINTENANCE ITEM	EVERY TRIP	MONTHLY	EVERY 3 MONTHS	EVERY 6 MONTHS	ANNUALLY	BEFORE/AFTER STORAGE	PROCEDURE TO BE PERFORMED:
							MAINTENANCE SCHEDULES ARE MINIMUM REQUIREMENTS. EXTENDED USE, EXTREME TEMPERATURES, HIGH HUMIDITY OR OTHER EXTREME CONDITIONS WILL REQUIRE MORE FREQUENT MAINTENANCE.
EMERGENCY EGRESS WINDOW(S)	X	X				X	OPEN AND CLOSE THE EMERGENCY EGRESS WINDOW(S) EVERY TRIP
ENTRY STEPS				X		X	CLEAN AND APPLY SILICONE OR TEFLON BASED DRY LUBE
EXTERIOR FIBERGLASS/METAL				X			APPLY NON-ABRASIVE WAX (EXCEPT ON DECALS)
			X				WASH WITH WARM WATER AND MILD DETERGENT
FRAME/ UNDERBELLY			X			X	CHECK FRAME FOR CHIPPED PAINT AND RUST, REPAINT AS NECESSARY
					X	X	CHECK FOR DAMAGE, LOOSE WIRES AND DEBRIS. CLEAN AS NECESSARY
HITCH/COUPLER					X	X	CHECK FOR DAMAGE AND WEAR. CLEAN AND LUBRICATE (WITH GREASE)
LP SYSTEM					X		HAVE SYSTEM TESTED FOR LEAKS BY A QUALIFIED DEALER
					X		PRESSURE
PLUMBING SYSTEM	X				X		DRAIN FRESH WATER HOLDING TANK AFTER EVERY TRIP. SANITIZE ANNUALLY (OR AS NEEDED).
	X						DRAIN AND FLUSH BLACK AND GRAY WATER HOLDING TANKS
					X	X	WINTERIZE SYSTEM BEFORE STORAGE (IN COLD CLIMATES)
			X		X	X	CHECK HOSES, FITTINGS, AND PIPES FOR LEAKS. TIGHTEN AS REQUIRED
ROOF AND ROOF ATTACHMENTS				X		X	CLEAN ROOF WITH WATER AND MILD DETERGENT
					X	X	CLEAN AND LUBE ROOF VENT MECHANISMS WITH LIGHT OIL
SAFETY EQUIPMENT				X			TEST AND CHECK FIRE EXTINGUISHER FOR PROPER CHARGE
	X	X				X	TEST AND CONFIRM EMERGENCY EGRESS WINDOW(S) FUNCTION PROPERLY
	X			X		X	CHECK OPERATION OF DETECTORS – RECHARGE AND REPLACE BATTERIES EVERY 6 MONTHS IF EQUIPPED

SEC.19 MAINTENANCE

MAINTENANCE ITEM	EVERY TRIP	MONTHLY	EVERY 3 MONTHS	EVERY 6 MONTHS	ANNUALLY	BEFORE/AFTER STORAGE	PROCEDURE TO BE PERFORMED: MAINTENANCE SCHEDULES ARE MINIMUM REQUIREMENTS. EXTENDED USE, EXTREME TEMPERATURES, HIGH HUMIDITY OR OTHER EXTREME CONDITIONS WILL REQUIRE MORE FREQUENT MAINTENANCE.
SLIDE ROOMS	X						CHECK SLIDE ROOF FOR DEBRIS – CLEAR AS NECESSARY
					X		SLIDE-OUT ROOM ADJUSTMENT PERFORMED BY A CERTIFIED RV SERVICE TECHNICIAN
	X		X			X	CHECK AND CLEAN ALL SEALS
WHEELS AND TIRES	X	X				X	CHECK TIRE INFLATION PRESSURE (SEE TIRE LABEL)
			X			X	INSPECT TIRES FOR WEAR/DAMAGE/ETC.
	X		X			X	CHECK WHEEL LUGS FOR PROPER TORQUE

A. AIR CONDITIONER (ROOF)

1. A/C Will Not Operate

⚠ WARNING

Working with any electrical system or appliance can be dangerous due to the risk of electrical shock. It is recommended that all inspections and repairs to be performed by your Dealer or an authorized service location.

- Ensure there is proper power supplied via an external shore power.
- Make sure the A/C is ON.
- Inspect all fuses and breakers found within the power center.
- Follow any other troubleshooting suggestions provided within the manufacturer's manual.

If the A/C is still inoperable, please contact your Dealer to inspect and repair as needed.

2. A/C Operates, but Coil Freezes and Compressor Cycles Prematurely

- Control setting may be set too low, causing compressor to cycle. Adjust as needed.
- Make sure there are no obstructions in the intake or exhaust.
- Clean the filter as needed.
- Inspect the intake baffle to ensure it is properly seated and not leaking or mixing with the output.
- Have your Dealer inspect coolant levels.

If the A/C is still not operating correctly, please contact your Dealer to inspect and repair as needed.

3. A/C Does Not Effectively Get Cold

- Begin operation of the A/C at the beginning of the day before temperatures rise.
- Offset "heat gain" effectively by:
 - Closing all windows and blinds.
 - Keep entrance doors closed.
 - Utilize the awning.
 - Avoid the use of heat-producing appliances as much as possible.
 - See [Section 10C](#).
- Ensure the outside coil is not obstructed or damaged.
- Ensure there is sufficient power to the RV.
- Have your Dealer verify the voltage at the A/C unit.

If the A/C is still not operating correctly, please contact your Dealer to inspect and repair as needed.

B. ELECTRICAL POWER

No 120-Volt Power to the RV

- Verify no breakers found within the power center have been tripped.
- Have your Dealer verify that there is power at the shoreline receptacle.

If there is still no power within the RV, please contact your Dealer to inspect and repair as needed.

SEC.20 BASIC TROUBLESHOOTING

C. FURNACE

⚠ WARNING

If the furnace is not functioning, do not attempt to make repairs or adjustments. Turn off the thermostat and the LP supply at the cylinders. All inspections and repairs should be performed by your Dealer or an authorized service location.

Furnace Does Not Ignite and/or Cycles Frequently

- Ensure there is sufficient propane within the cylinders.
- Remove possible obstructions in or on the furnace exhaust.
- Inspect the furnace fuse within the power center.
- Check that the return air is not obstructed. Items stored in front of the return should be relocated.
- Ensure all heat registers are open and unobstructed.
- Ensure that sufficient power is being supplied to the furnace.

If the furnace is still not functioning properly, please contact your Dealer to inspect and repair as needed.

D. INTERIOR LIGHTS

1. If Lights Flicker

- The converter may be over-heating.
 - Reduce converter load by operating only appliances and lights that are needed.
 - Open the compartment to allow for additional ventilation.
- Check the wire connections at the switch and at the light to ensure they are not loose.

If issue persists, please contact your Dealer to inspect and repair as needed.

2. Lights Dim or are Half Bright

- Ensure sufficient power is being supplied
- Check for low battery voltage and recharge if needed.
- Possible weak or lost ground connection. Check for loose connections.
- Have the converter inspected by your Dealer.

If issue persists, please contact your Dealer to inspect and repair as needed.

E. MICROWAVE

Will Not Operate

- Make sure the door is properly closed.
- Reset the time and select START.
- Check for sufficient power supply.
- Inspect the breaker to make sure that it was not tripped.

If issue persists, please contact your Dealer to inspect and repair as needed.

F. MONITOR PANEL

1. No Lights at Control Panel When Switch is Pressed

- Ensure proper power is being supplied.
- Ensure the fuse behind the panel is not blown.
- Check the mini fuses and breakers in the front compartment.
- Have the panel tested by your Dealer.

If issue persists, please contact your Dealer to inspect and repair as needed.

2. Holding Tank Lights Deliver False Readings

- Verify the tank is empty.
- Clean any possible debris or build-up on the probe sensor.
- Clean and flush the tank by using a solution of two-parts vinegar mixed to one-part water.
- Repeat as needed.

If issue persists, please contact your Dealer to inspect and repair as needed.

G. OUTSIDE RECEPTACLE

No Power to Exterior Receptacles

- Make sure the RV is properly connected to external shore power.
- Check the breaker at the generator (Customer Supplied).
- Ensure the GFCI receptacle was not tripped.
- Check the breaker found within the power center.

If issue persists, please contact your Dealer to inspect and repair as needed.

H. PORTABLE GENERATOR (CUSTOMER SUPPLIED)

1. Starter Engages When Holding Start Button, but Generator Does Not Start

- Ensure the generator has sufficient fuel. Generator is inoperable if the tank is under ¼ full.
- Check the oil level and correct as needed.

If issue persists, please contact your Dealer to inspect and repair as needed.

2. If Generator Start Button is Pushed,

and Nothing Happens

- Ensure battery disconnect is not engaged.
- Check 12-volt fuse on generator.
- Check the breaker found at the generator.

If issue persists, please contact your Dealer to inspect and repair as needed.

3. Generator Starts, but Lacks Sufficient Power Supply

- Check the breaker at generator.
- Check the main breaker within the RV.

If issue persists, please contact your Dealer to inspect and repair as needed.

4. Generator Makes Clicking Sound When Attempting to Start

- Check battery voltage and recharge if needed.
- Check for poor ground or battery connection.

If issue persists, please contact your Dealer to inspect and repair as needed.

I. PROPANE GAS

Smell of Gas in or Around Unit

- Ensure propane cylinders are not overfilled.

If issue persists, please contact your Dealer to inspect and repair as needed.

WARNING

Working on the propane system, or with propane can be quite dangerous. Always have LP related repairs performed by your Dealer or a qualified service representative.

SEC.20 BASIC TROUBLESHOOTING

DANGER

IF YOU SMELL PROPANE:

1. Extinguish all open flames, pilot lights, smoking materials, etc.
2. Refrain from touching any electrical switches.
3. Shut off the propane supply at the LP bottles.
4. Ventilate the RV by opening all doors, windows, and vents.
5. Remain at a safe distance from the RV until all odor clears.
6. Have the propane system inspected and repaired as needed before continuing use.

Failure to comply with these instructions may result in explosion of the RV leading to serious injury or death.

J. REFRIGERATOR

1. Control Panel Lights Are Not Illuminating

- Ensure there is proper power being supplied to the RV via external shore power.
- Check the battery voltage and recharge as needed.
- Check breaker found within the power center.

If issue persists, please contact your Dealer to inspect and repair as needed.

2. Lights Are Illuminating, but Not Properly Cooling

- Ensure there is sufficient power being supplied to the RV via external shore power.

- Make sure the refrigerator is level.
- Allow sufficient time for the refrigerator to cool. Loading chilled and frozen foods will help to cool the unit faster.

If issue persists, please contact your Dealer to inspect and repair as needed.

3. Frost Buildup on Evaporator Fins

- Allow the freezer and refrigerator to thaw.
- Refrain from overloading the provided area. Airflow and circulation are vital for proper cooling and to prevent frost buildup.

If issue persists, please contact your Dealer to inspect and repair as needed.

K. RUNNING LIGHTS

1. Running Lights Not Operating

- Check the fuse to ensure it is not blown.
- Check wiring connections.
- Replace the light as needed.

If issue persists, please contact your Dealer to inspect and repair as needed.

L. SLIDE-OUT

1. Runs In and Out Slowly, Binds, and/or Squeaks

- Ensure sufficient power is supplied.
- Lubricate slide-out rollers and gear pack (through frame slides only) with dry silicone spray lubricant.

If issue persists, discontinue the use of the slide-outs and contact your Dealer to inspect and repair as needed.

2. Water in Entering at the Rear Corners

- Verify that the exterior seals are making proper contact with the slide-out box. Seals may be flipped in the wrong direction.
- Ensure the seals are clean and free of any obstructions, dirt, or debris.
- Make sure the weep hole found in the ramp pan is clean and unobstructed.

If issue persists, please contact your Dealer to inspect and repair as needed.

3. Room Will Not Move In or Out

- Ensure there is sufficient power source.
- Verify battery voltage and recharged as needed.
- Check the auto-resetting mini-breaker located in the front fifth wheel bulkhead compartment. See the manufacturer's manual for additional information.

If issue persists, please contact your Dealer to inspect and repair as needed.

M. TERMINATION VALVE

Leak at Termination Valve

- Ensure debris is not seated within valve.
- Replace valve as needed.

If issue persists, please contact your Dealer to inspect and repair as needed.

N. TV ANTENNA

Poor TV Reception

- Check that the Antenna Power is ON. Note that it is located in the ceiling behind the bedroom TV.
- Check the connections at both

the TV and wall plate.

If issue persists, please contact your Dealer to inspect and repair as needed.

O. WASTE TANK

Waste Tank (Black) Will Not Properly Drain

- Check for debris or buildup within the tank and clean as needed. To prevent buildup:
 - Use RV biodegradable toilet paper
 - Use plenty of water when flushing
- Check termination valve for possible obstructions.

If issue persists, please contact your Dealer to inspect and repair as needed.

P. WATER HEATER—TANKLESS

Follow any other troubleshooting and maintenance suggestions provided within the manufacturer's manual.

Q. WATER PUMP

1. Pump Inoperable

- Ensure there is proper power source.
- Check pump switch and connection at the monitor panel.
- Inspect the fuse in power center to ensure it isn't blown.
- Verify the water is not frozen.

If issue persists, please contact your Dealer to inspect and repair as needed.

2. Pump Will Not Prime

- Ensure there is sufficient water in the tank. This can be checked at the monitor panel.

SEC.20 BASIC TROUBLESHOOTING

- Verify there isn't trapped air in the hot water heater.
- Verify the water is not frozen.

If issue persists, please contact your Dealer to inspect and repair as needed.

3. Pump Runs Even When Water Is Off

- Ensure all water sources are turned off.
- Turn off the pump using the switch in the convenient center or the monitor panel.
- Check for water collections near or around plumbing appliances and fittings.
- Inspect toilet for leaking valves.

If issue persists, please contact your Dealer to inspect and repair as needed.

R. WATER SYSTEM

Wet Areas Near Water Connections, Pump Runs While the Faucets are Closed, and No Other Fresh Water Fixtures are Being Used.

- Check for water leaks.
- Close all valves and low points to tanks and drains.
- Ensure all water fixtures are properly closed.
- Verify that all fixtures and connections are tight.

DO NOT over tighten fittings. This may damage seals and cause additional leakage.

A/C ELECTRICITY

Alternating current is an electric current which periodically reverses direction and changes its magnitude continuously with time in contrast to direct current which flows only in one direction. For purposes of this manual, it refers to 120-volt.

A/C

(Abbreviated 120 VAC).

AMP

Short for ampere, the electrical current unit of measure. RV sites with electric hookup will specify the maximum amps supported, which generally come in units of 20, 30, or 50 amps. The RV power connector must match the various plugs of the site amp rating. Keep in mind that if using a reducer, your usage of items will be limited. If an outlet is not labeled, please have it tested prior to plugging into it.

AUXILIARY BATTERY

An Auxiliary battery allows you to power 12-volt DC devices anywhere, any time. This is a Customer/ Dealer purchased, installed item. Brinkley RV recommends a group 27 deep cycle battery.

AWNING

A canvas or other artificial material which extends from the RV body to provide shade. Awnings are generally placed on the entrance side of the RV. Not meant to be shelter or protection from storms.

BLACK WATER

Is human waste collected from the toilet. The black water can be emptied through a black water hose at a dedicated RV sewage dump.

BLUE BOY

Also known as a Honey Wagon, is a portable waste tank that allows you to dump your RV's sewage or gray water without taking your whole RV to the dumpsite.

BOONDOCKING

Is when you camp without hookups to electricity, water or sewage. Keep in mind that without alternate charge this is taxing on your auxiliary battery.

BREAKAWAY SWITCH

Is designed to bring a trailer to a safe stop by activating the electric brakes on the trailer, should the trailer be disconnected from the tow vehicle while driving. Do not pull this to test your brakes. You must have operational electric brakes on the unit, the 12-volt battery must be charged & the switch cable must be attached to the vehicle.

BRAKE CONTROLLER

Is an electronic device that activates and, as the word suggests, controls the electric brakes of a trailer. This device can be integrated or added to the tow vehicle. **NOT SUPPLIED WITH RV.**

BRITISH THERMAL UNIT (BTU)

Measurement of the heat content of fuels or energy sources. It is the quantity of heat required to raise the temperature of one pound of liquid water by 1 degree Fahrenheit at the temperature that water has its greatest density (approximately 39 degrees Fahrenheit).

CAMBER (WHEEL ALIGNMENT)

Is one of the angles made by the wheels of a vehicle; specifically, it is the angle between the vertical axis of a wheel and the vertical axis of the vehicle when viewed from the front or rear.

CAMPING

An outdoor activity involving overnight stays away from home, either without shelter or using basic shelter such as a tent or a recreational vehicle.

CARBON MONOXIDE

A colorless, odorless toxic flammable gas formed by incomplete combustion of carbon.

GLOSSARY

CARGO WEIGHT

The actual weight of all items added to the Curb Weight of the vehicle or trailer. Exceeding this weight could void certain warranties or cause damage to the RV.

CARGO CARRYING CAPACITY (CCC)

The Maximum permissible weight of personal belongings that can be added up. It is equal or less than Gross Vehicle Weight Rating minus Unloaded Vehicle Weight, full freshwater weight, and full LP (liquid propane) gas weight, and holding tank weights.

CITY WATER

This is a faucet at your campsite that allows you to connect your RV directly to a city water supply. No pump needed.

CONDENSATION

Is the water droplets that form on your RV walls, windows and make things feel wet. This can cause mold and mildew to form in your RV on walls, under the mattress, and more.

CONVERTER

An RV converter is responsible for converting standard 120-volt AC power into 12-volt DC power. The unit must be plugged in for this device to work.

CURB WEIGHT

The actual weight of a vehicle or trailer, including all standard equipment, full fuel tanks, full freshwater tanks, full propane bottles, and all other equipment fluids, but before taking on any persons or personal cargo.

CURBSIDE

This refers to the side of the camper that faces the curb when parked. Also referred to as the door side, DS, or passenger side.

DC ELECTRICITY

Direct current is one-directional flow of electric charge. The Auxiliary Battery and converter both provide DC electricity. (Abbreviated 12 VDC).

DEALER

Means any person who sells or solicits or advertises the sale of new recreational vehicles.

DINETTE

Booth-like dining area. Table usually drops or is removable to convert into a bed at night.

DRY CAMPING

Camping when there is no city water hookup or shore power (i.e., using only the water and power available in the camper and not from any other source).

DRY WEIGHT

Is the weight of an RV as built at the factory. (UVW= Unloaded Vehicle Weight).

DSI (Direct Spark Ignition)

This term refers to the method of igniting the main burner on a propane fired appliance. The burner is lit with an electric spark and the flame is monitored by an electronic circuit board. This ignition system is used in refrigerators, furnaces, and water heaters. There is now a version of stove tops that light the burners with a DSI ignition.

DUAL ELECTRICAL SYSTEM

RV equipped with lights, appliances which operate on 12-volt battery power when self-contained, and with a converter, on 120VAC when in campgrounds or with an on-board generator.

DUALY

A truck having two wheels on each side of the rear axle for a total of four wheels. This allows for more load capability.

DUCTED A/C

Air conditioning supplied through a ducting system in the ceiling. This supplies cooling air at various vents located throughout the RV.

DUCTED HEAT

Warm air from the furnace supplied to various locations in the RV through a ducting system located in the floor. (Similar to house heating systems).

DUMP STATION

Site where you drain your gray water (waste) and your black water (sewage) tanks. In most states, it is illegal to drain your tanks anywhere except dump stations.

DUMP VALVE

Another name for the T-handle valve used to release and drain the black tank (sewage) and gray tank (waste).

EGRESS WINDOW

Is essentially an emergency exit window in your RV that allows for the safe evacuation of occupants. (These windows are labeled).

FIFTH WHEEL (FW)

A trailer and hitch configuration connected to the tow truck directly above the rear axle by way of a special fifth wheel hitch. This causes several feet of the connected trailer to hang over the tow truck, placing about 15 to 25% of the trailer's weight on the rear axle of the truck. Commercial trucks and trailers use this hitch configuration. Also commonly spelled as 5th wheel.

FRESH WATER

The freshwater system provides potable water to the kitchen sink, shower, bathroom lavatory, toilet, water heater and outside shower.

FRESH WATER TANK

Tank for holding freshwater for drinking, cooking, and bathing while not connected to a city water supply.

FULL HOOKUP SITE

A campsite that has city water, shore power and sewer hook-ups or connections available.

FULL-TIMERS or FULL-TIMING

The term used for people who live in their RV full-time, or at least the vast majority of their time.

GALLEY

The kitchen in an RV.

GENERATOR

An engine powered device fueled by gasoline or diesel fuel, and sometimes propane, for generating 120-volt AC power.

GENSET

Abbreviation for built in generator.

GOOSENECK

A trailer and hitch configuration connected to the tow truck directly above the rear axle by way of a standard ball hitch in the truck bed and a vertical, slender arm on front of the trailer.

GRAY WATER

Term associated with the wastewater holding tank. Water from the sink drains, shower and washer/dryer go into this tank.

GROSS AXLE WEIGHT RATING (GAWR)

The MAXIMUM ALLOWABLE WEIGHT each axle assembly is designed to carry, as measured at the tires, therefore including the weight of the axle assembly itself. GAWR is established by considering the rating of each of its components (tires, wheels, springs, axle), and rating the axle on its weakest link. The GAWR assumes that the LOAD IS EQUAL ON EACH SIDE.

GROSS CARRYING CAPACITY (GCC)

Means the maximum carrying capacity of your camper. The GCC is equal to the GVWR minus UVW. The GCC will be reduced by the weight of fresh water or other tanks, propane, occupants,

GLOSSARY

personal items or Dealer installed accessories. (Also referred to Cargo Carrying Capacity).

GROSS COMBINED WEIGHT RATING (GCWR)

The MAXIMUM ALLOWABLE COMBINED WEIGHT of the tow vehicle and attached towed vehicle. GCWR assumes that both vehicles have functioning brakes, with exceptions in some cases for very light towed vehicles, normally less than 1,500 pounds. (Check your tow vehicle's towing guide.)

GROSS TRAILER WEIGHT RATING (GTWR)

The MAXIMUM TOWED VEHICLE WEIGHT. Each component (receiver, drawbar, ball) of a ball-type hitch has its own rating. Some ball-type hitches have separate ratings when used with a weight distributing system.

GROSS VEHICLE WEIGHT RATING (GVWR)

The MAXIMUM ALLOWABLE WEIGHT of the fully loaded vehicle, including liquids, passengers, cargo, and the tongue weight of any towed vehicle.

HEAT EXCHANGER

A device that transfers heat from one source to another. For example, there is a heat exchanger in your furnace, the propane flame and combustion products are contained inside the heat exchanger that is sealed from the inside area. Inside air is blown over the surface of the exchanger, where it is warmed and blown through the ducting system for room heating. The combustion gases are vented to the outside air.

HEAT STRIP

A heat strip is an electric heating element located in the air conditioning system with the warm air distributed by the air conditioner fan and ducting system. They are typically 1500-watt elements (about the same wattage as an electric hair dryer) and have limited function.

HEPVO VALVE

Is a unique self-sealing waste valve that prevents

the escape of foul sewer air from waste discharge systems, and actively maintains the pressure equilibrium in soil and waste installations.

HIGH PROFILE

Is any vehicle that has a large, exposed surface area that cross winds can affect.

HITCH

The fastening unit that joins an RV to the tow vehicle.

HITCH WEIGHT

The amount of the camper's weight that rests on the tow vehicle. It should be approximately 12% - 15% with conventional travel trailers; approximately 18% -21% for fifth wheels.

HOLDING TANKS

These are containers that store the fresh and wastewater in the RV. There are three types, freshwater, wastewater, and black water holding tanks.

HONEY WAGON

A truck or trailer that will travel to campsites, release the waste from your black and gray tanks and carry it off.

HOOKUPS

The ability of connecting to a campground's facilities. The major types of hookups are electrical, water and sewer. If all three of these hookups are available, it is termed full hookup. Hookups may also include telephone and cable TV in some campgrounds.

HOUSE BATTERY

One or more batteries in an RV for operating the 12-volt lights, appliances, and systems. House batteries can be 12-volt units tied in parallel or pairs of 6-volt batteries tied in series (to double the voltage). The term house battery is of more significance in motor homes because they contain one or more other batteries for the operation of the engine, referred to as the chassis or starting batteries.

INVERTER

An inverter is a device that changes 12-volt battery power to 120-volt AC power. It is used when “boon docking” (camping without hookups) to power certain 120 VAC only devices like a microwave oven. The amount of available power depends on the storage capacity of the batteries and the wattage rating of the inverter.

ISLAND QUEEN or ISLAND KING

A king or queen-sized bed with walking space on both sides.

JACKKNIFE

The 90° angle obtained from turning/backing fifth wheel or travel trailer with tow vehicle. Jackknifing a short bed truck towing a fifth wheel without the use of a slider hitch or extended fifth wheel pin box can result in damage to the truck cab or breaking out the back window of the truck cab from the truck and fifth wheel “colliding.”

KING PIN

The pin by which a fifth wheel trailer attaches to the truck. It slides into the fifth wheel hitch and locks in place.

KING PIN WEIGHT

The actual weight pressing down on the fifth wheel hitch by the trailer. The recommended amount of King Pin Weight is 15%-25% of the GTW, also called Pin Weight.

LAMINATE

A sandwich of structural frame members, wall paneling, insulation and exterior covering, adhesive-bonded under pressure and/or heat to form the RV’s walls, floor and/or roof.

LANDING GEARS

See Leveling Jack.

LEVELING

Positioning the RV in camp so it will be level, using ramps (also called levelers) placed under the wheels, built-in scissors jacks, or power leveling jacks.

LEVELING JACK

A jack lowered from the underside of trailers and motor homes for the purpose of leveling the vehicle. A leveling jack is designed to bear a significant portion of the RV’s weight.

LP GAS

Liquified Petroleum Gas, commonly written as “LP Gas.” Two examples of LP Gas are propane and butane. LP Gas is heavier than air in gas form and about half the weight of water in liquid form. LP gas is used to fuel appliances in the RV, such as the stove, oven, water heater and refrigerator. Propane tanks are usually rated as pounds or gallons.

LOW POINT

The lowest point in the plumbing. Drains are placed here so that water will drain out of the lower end of the camper when flushing or winterizing the water system. These drains must be closed when you fill the water tank.

MOTORHOME (MH)

A motor vehicle built on a truck or bus chassis and designed to serve as self-contained living quarters for recreational travel.

NET CARRYING CAPACITY (NCC)

The MAXIMUM WEIGHT of all personal belongings, food, fresh water, propane, tools, Dealer installed accessories, etc., that can be carried by the RV.

NON-POTABLE WATER

Water NOT suitable for human consumption.

OEM

This refers to the original equipment manufacturer of the individual appliances or components.

PATIO MAT

Carpet or woven mat for use on ground outside of RV. Used whether or not a concrete patio pad is available where camping.

GLOSSARY

PAYLOAD CAPACITY

The maximum allowable weight that can be placed in or on a vehicle, including cargo, passengers, fluids and fifth-wheel or conventional hitch loads.

PILOT

A pilot is a small standby flame that is used to light the main burner of a propane fired appliance when the thermostat calls for heat. Pilots can be used in furnaces, water heaters, refrigerators, ovens, and stove tops.

PORPOISING

A term used to define the up and down motion in an RV while traveling. Also commonly referred to as “chucking.”

POWER SOURCE

Also referred to as shore power, this refers to the receptacle outlet you are using to plug in your shoreline power cord. This can be a campsite power box or electrical box, a residential receptacle outlet specifically wired for your camper or a generator (Customer Supplied).

PRIMITIVE SITE

A campsite that may have city water, shore power or sewer hook-ups but not all of them; primitive sites may have no hook-ups or connections at all.

PROPANE

LPG, or liquified petroleum gas, used in RVs for heating, cooking and refrigeration. Also called bottle gas, for manner in which it is sold and stored. This is the proper term in the RV industry when referring to “LP Gas.”

PULL-THROUGH SITES

Campsites you can drive through and park (without having to back up into the site).

REFER

Slang for “Refrigerator.”

RIG

What many RV’ers call their units.

ROADSIDE

The side of the trailer that faces the road when it is parked. Also called the Streetside, Off-Door Side or ODS.

ROOF AIR CONDITIONING

Air conditioning unit mounted on roof of RV, to cool the RV when it is parked. When moving, most RVs are cooled by separate air conditioning units which are components of the engine, or they may be cooled by a roof top if a proper size generator is installed.

RV

Short for Recreation Vehicle, a generic term for all pleasure vehicles which contain living accommodations. Multiple units are RVs and persons using them are RV’ers.

RVDA

Abbreviation for Recreational Vehicle Dealer’s Association.

RVIA

Abbreviation for Recreational Vehicle Industry Association.

SELF CONTAINED

RV which needs no external electrical, drain or water hookup. Thus, it can park overnight anywhere. Of course, self-contained units can also hook up to facilities when at campgrounds.

SANITIZATION

Refers to the camper’s freshwater system that has been sanitized with chlorine bleach before use or after storage.

SHORELINE POWER CORD

This is the electrical power cord that runs from the camper to the campsite shore power outlet.

SLEEPING CAPACITY WEIGHT RATING (SCWR)

The manufacturer’s designated number of sleeping positions multiplied by 154 pounds (70 kilograms).

SLIDE-OUT

A compartment added to an RV to increase interior space. It slides into the body during travel and slides out when parked.

SNOWBIRD

Term for someone in a northern climate that heads “south” in winter months.

STINKY SLINKY

Slang for the sewer hose, constructed from a spiral wire covered with vinyl. One end attaches to the RV piping and the other into the local sewer dump facilities.

STREETSIDE

The side of the trailer that faces the street when parked. Also called the Roadside, Off-Door Side or ODS.

SURGE PROTECTOR

Device (Customer Supplied) that is installed at the power supply location designed to prevent “surges” or “spikes” in electrical current that may damage the RV’s electrical/electronic components.

SWAY

Fishtailing action of the trailer caused by external forces that set the trailer’s mass into a lateral (side-to-side) motion. The trailer’s wheels serve as the axis or pivot point. Also known as “yaw.”

THERMOCOUPLE

A thermocouple is a device that monitors the pilot flame of a pilot model propane appliance. If the pilot flame is extinguished the thermocouple causes the gas valve to shut off the flow of gas to both the pilot flame and the main burner.

TIP OUT

The term used for an area or room in an RV that tips out for additional living space. The Tip-Out was generally used in older RVs. Newer RVs mainly use a slide-out.

TIRE RATINGS

The **MAXIMUM LOAD** that a tire may carry is engraved on the sidewall, along with a corresponding **COLD** inflation pressure. A reduction in inflation pressure requires a reduction in load rating. Tire manufacturers publish charts that establish the load capacity at various inflation pressures.

TOE (WHEEL ALIGNMENT)

Toe is the measure of whether the front of the wheels (looking down from the top) are closer (toe-in) or farther (toe-out) than the back of the wheels.

TONGUE WEIGHT, TONGUE LOAD, VERTICAL LOAD (TWR/TLR/VLR)

Tongue Weight, Tongue Load, Vertical Load Rating Different terms for the **MAXIMUM VERTICAL LOAD** that can be carried by the hitch **UNLOADED**.

TRAILER BRAKES

Brakes that are built into the trailer axle systems and are activated either by electric impulse or by a surge mechanism. The overwhelming majority of RVs utilize electric trailer brakes that are actuated when the tow vehicle’s brakes are operated, or when a brake controller is manually activated. Surge brakes utilize a mechanism that is positioned at the coupler, that detects when the tow vehicle is slowing or stopping and activates the trailer brakes via a hydraulic system (typically used on boats).

TRAVEL TRAILER (TT)

Also referred to as “conventional trailers,” these types of rigs have an A-frame and coupler and are attached to a ball mount on the tow vehicle. Travel trailers are available with one, two or three axles. Depending upon tow ratings, conventional trailers can be towed by trucks, cars or sport-utility vehicles.

GLOSSARY

UNDERBELLY

The RV's under-floor surface, which is protected by a weatherproofed material.

UTQGL (UNIFORM TIRE QUALITY GRADE LABELING)

A program that is directed by the government to provide consumers with information about three characteristics of the tire: tread wear, traction, and temperature. Following government prescribed test procedures, tire manufacturers perform their own evaluations for these characteristics. Each manufacturer then labels the tire, according to grade.

UV DEGRADATION

A breaking down of material due to the sun's harsh ultraviolet rays.

UNLOADED VEHICLE WEIGHT (UVW)

The WEIGHT of a vehicle as built at the factor with full fuel, engine (generator) oil and coolants. It does not include cargo, fresh water, propane, occupants, or Dealer installed accessories.

WASTEWATER TANKS

The gray water tank holds the wastewater from the sinks and showers. The black water tank holds the waste from the toilet.

WATER PRESSURE REGULATOR

Device (Customer Supplied) installed on the water hose attached to city water to limit the water pressure entering the RV. Most regulators limit water pressure to 40 psi.

WEIGHT AND LOAD

These terms are generally used interchangeably. For the purposes of understanding RV applications:

- Vehicles have WEIGHT, which impart LOADS to tires, axles and hitches.

- Scale measurements taken when weighing, are LOADS carried by the tires. The measured LOADS are used to calculate Gross Combination Weight (GCW) Gross Vehicle Weight (GVW), Gross Axle Weight (GAW), and Hitch Loads.

WET WEIGHT

The weight of the vehicle with the fuel, freshwater and propane tanks full.

Note these important weights:

Propane	4.25 lbs. per gallon
Water	8.3 lbs. per gallon
Gasoline	6.3 lbs. per gallon
Diesel fuel	6.6 lbs. per gallon

WIDE BODY

An RV having an external body width greater than 96 inches (8 feet). The most common wide-body widths are 100" and 101."

WINTERIZED

Refers to a camper that has been prepared for storage. The water systems have been drained and RV antifreeze has been added to protect the water lines and drains. The low point drains should be in the open position.

YAW

Fishtailing action of the trailer caused by external forces that set the trailer's mass into a lateral (side-to-side) motion. The trailer's wheels serve as the axis or pivot point. Also known as "sway."

